

# TF Series Temperature Controller User Manual



## Features:

- ⊙ Optional input signal types and models
- ⊙ With many functions of measured display, control output, alarm output, analog output, RS485 communication, etc.
- ⊙ Optional many types of PID arithmetic and with auto-tuning function.
- ⊙ Using for industrial machinery, machine tools, measuring instruments.
- ⊙ Economical and easy operation.

The instruction explain instrument settings, connections, name and etc, please read carefully before you use the temperature controller.

## ■ Safe Caution

### ⚠ Warning

- 1) When the failure or abnormal of products lead to a system of major accidents, please set the proper protection circuit in the external.
- 2) Please don't plug in before completing all the wire. Otherwise it may lead to electric shock, fire, fault.
- 3) Not allow to use outside the scope of product specification, otherwise it may lead to fire, fault.
- 4) Not allow to use in the place where is inflammable and explosive gas.
- 5) Do not touch wire connectors when the power on, otherwise you may get an electric-shock.
- 6) Do not remove, repair and modification this product, otherwise it may lead to electric shock, fire, fault.

### ⚠ Caution

- 1) The product should not be used in a nuclear plant and human life associated medical equipment.
- 2) The product may occur radio interference when it used in home. You should take adequate countermeasures.
- 3) The product get an electric shock protection through reinforced Insulation. when the product is embedded in the devices and wiring, please subject to the specification of embedded devices.
- 4) In order to prevent surge occurs, when using this product in the place of over 30m indoor wiring and wiring in outdoor, you need to set the proper surge suppression circuitry.
- 5) The product is produced based on mounting on the disk. In order to avoid to touch the wire connectors, please take the necessary measures on the product
- 6) Be sure to observe the precautions in this manual, otherwise there is a risk of a major injury or accident.
- 8) To prevent to damage the machine and prevent to machine failure, the product is connected with power lines or large capacity input and output lines and other methods please install proper capacity fuse or other methods of protection circuit.
- 9) Please don't put metal and wire clastic mixed with this product, otherwise it may lead to electric shock, fire, fault.
- 10) Please tighten screw torque according to the rules. If not, it may lead to electric shock and fire.
- 11) In order not to interfere with this products to dissipate heat, please don't plug casing around the cooling vent hole and equipment.
- 12) Please don't knock or rub the panel with rigid thing.
- 13) The readers of this manual should have basic knowledge of electrical, control, computer and communications.
- 14) The illustration, example of data and screen in this manual is convenient to understand, instead of guaranteeing the result of the operation.
- 15) In order to use this product with safety for long-term, regular maintenance is necessary. The life of some parts of the equipments are by some restrictions, but the performance of some will change for using many years.
- 16) Without prior notice, the contents of this manual will be change. We hope these is no any loopholes, if you have questions or objections, please contact us.

### ⚠ Caution of Install & Connection:

#### 1. Installation:

- 1) This product is used in the following environmental standards.  
(IEC61010-1) [Overvoltage category II \ class of pollution 2]
- 2) This product is used in the following scope: surrounding environment, temperature, humidity and environmental conditions.  
Temperature: 0~50°C; Humidity: 45~85%RH; Environment condition: Indoor warranty, The altitude is less than 2000m.
- 3) Please avoid using in the following places:  
The place will be dew for changing temperature; with corrosive gases and flammable gas; with vibration and impact; with water, oil, chemicals, smoke and steam facilities with Dust, salt, metal powder; and with clutter interference, static electric and magnetic fields, noise; where has air conditioning or heating of air blowing directly to the site.
- 4) On the occasion of the installation, please consider the following before installing several.  
In order to protect heat saturated, please ensure adequate ventilation space.  
Please consider connections and environment, and ensure that the products below for more than 50mm space.  
Please avoid to installed over the machine of the calorific value (Such as heaters, transformer, semiconductor operations, the bulk resistance).  
When the surrounding is more than 50°C, please using the force fan or cooling fans. But don't let cold air blowing directly to the product.  
In order to improve the anti - interference performance and security, please try to stay away from high pressure machines, power machines to install.  
Don't install on the same plate with high pressure machine and the product.  
The distance should be more than 200mm between the product and power line.

## 2. Cable caution:

- 1) Please use specified compensation wire in the place of TC input; Please use insulated TC if the measured device is heated metal.
- 2) Please use the cable of lesser resistance in the place of RTD input, and the cable (3 wire) must be no resistance difference, but the total length is within 5m.
- 3) In order to avoid the effect of noise, please put the input signal away from meter cable, power cable, load cable to wiring.
- 4) In order to reduce the power cables and the load power cables on the effect of this product, please use noise filter in the place where easy to effect.  
You must install it on the grounding of the disk if you use the noise filter, and make the wiring to be shortest between noise filter output side and power connectors.  
Don't install fuse and switch on the wiring of noise filter output side, otherwise it will reduce the effect of noise filter.
- 5) It takes 5s from input power to output. If there is a place with interlocking actions circuit signal, please use timer relay.
- 6) Please use twisted pair with a shield for analog output line, and to ensure the reliability of signal, and connect Common mode choke on the front of signal receiver to suppress lines affected by interference if necessary, so that to
- 7) Please use twisted pair with a shield for remote RS485 communication cable, and deal with the shield on the host side earth, otherwise it will reduce the effect of noise filter.
- 8) This product is not the fuse; please set according to rated voltage 250V, rated current 1A if you need; fuse type: relay fuse.
- 9) Please use the suitable screw force and crimp terminal.  
The screw terminal size: M3X8 (with 6.8X6.8 square base)  
Recommended tightening torque: 0.4N.m  
Proper cables: 0.25~1.65mm single cable/multiple core cable
- 10) Please don't put the Crimp terminal or bare wire part contact with adjacent connector.

## Model Illustration

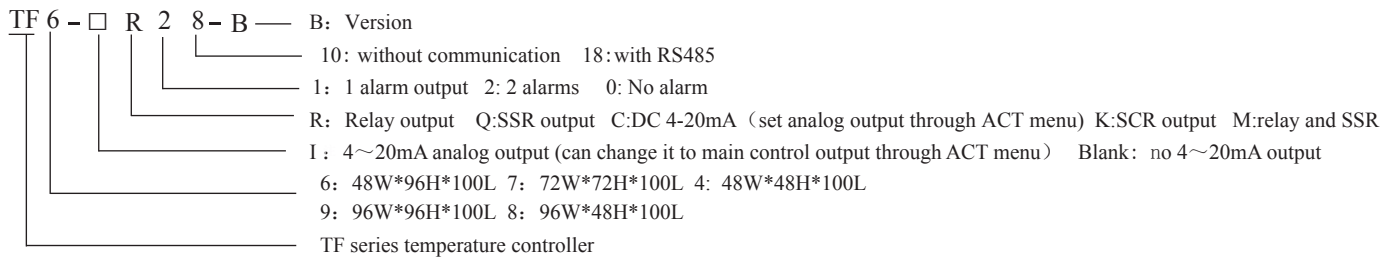

Please note that Size 48H\*48Wmm and 72H\*72Wmm temperature controller do not have 4-20mA analog output function

## Ordered Models

Model	Control output	Alarm	Analog Output 4~20mA	RS485
TF□-IR28	Relay output / 4~20mA	2	Yes	Yes
TF□-IQ28	SSR / 4~20mA	2	Yes	Yes
TF□-C28	4~20mA	2	can be optional	Yes
TF□-R1	Relay	1	No	No
TF□-M1	Relay and SSR	1	No	No

□: Optional dimensions

## Specifications

### 1、Electrical parameters

Sample rate	2SPS
Relay capacity	AC 250V /3A Life of rated load>100000 times
Power supply	AC/DC 100~240V (85-265V)
Power consumption	< 6VA
Environment	Temperature of indoor: -20~55℃ no condensation, Humidity:<85%RH, altitude<2000m
Storage environment	-20~60℃, no condensation
SSR output	DC 24V pulse level, load<30mA
Current output	DC 4~20mA load < 500Ω, Temperature drift 250PPM
Communication port	RS485 port Modbus-RTU protocol, max input 30units
Insulation impedance	Input, output, power cabinet > 20MΩ
ESD	IEC/EN61000-4-2 Contact ±4KV /Air ±8KV perf. Criteria B
Pulse tripp anti-interference	IEC/EN61000-4-4 ±2KV perf. Criteria B
Lightning surge	IEC/EN61000-4-5 ±2KV perf. Criteria B
Frequency drop	IEC/EN61000-4-29 0%~70% perf. Criteria B
Dielectric strength	Signal input & output & power 1500VAC 1min, below 60V Low voltage circuit between DC500V, 1min
Total weight	About 400g

Shell material	The shell and panel frame PC/ABS (Flame Class UL94V-0)
Panel material	PET(F150/F200)
Power-off data protection	10 years, times of writing:100w times
Protection level of panel	IP65(IEC60529)
Safety Standard	IEC61010-1 Overvoltage category II

## 2、measured signal specifications

Input type	symbol	Measuring range	Resolution	Accuracy	Input impedance/ auxiliary current	Code
K	Ⓚ	-50~999	1℃	0.5%F.S±3digits	>500kΩ	0
J	Ⓝ	0~999	1℃	0.5%F.S±3digits	>500kΩ	1
E	ⓔ	0~850	1℃	0.5%F.S±3digits	>500kΩ	2
T	Ⓣ	-50~400	1℃	0.5%F.S±2℃	>500kΩ	3
PT100	ⓅⓉ	-200~600	1℃	0.5%F.S±3digits	0.2mA	4
CU50	Ⓒⓤ	-50~150	1℃	0.5%F.S±3℃	0.2mA	5
CU100	Ⓒⓤ	-50~150	1℃	0.5%F.S±1℃	0.2mA	6
0~50mV	ⓂⓋ	-199~999	12bit	0.5%F.S±3digits	>500kΩ	7
0~400Ω	ⓇⓄ	-199~999	12bit	0.5%F.S±3digits	0.2mA	8
* 4~20mA	Ⓜⓐ	-199~999	12bit	0.5%F.S±3digits	100Ω	9
* 0~10V	Ⓥ	-199~999	12bit	0.5%F.S±3digits	>1MΩ	10

Please noted it when placing order if need 4-20mA or 0-10V

## 3、Isolation diagram

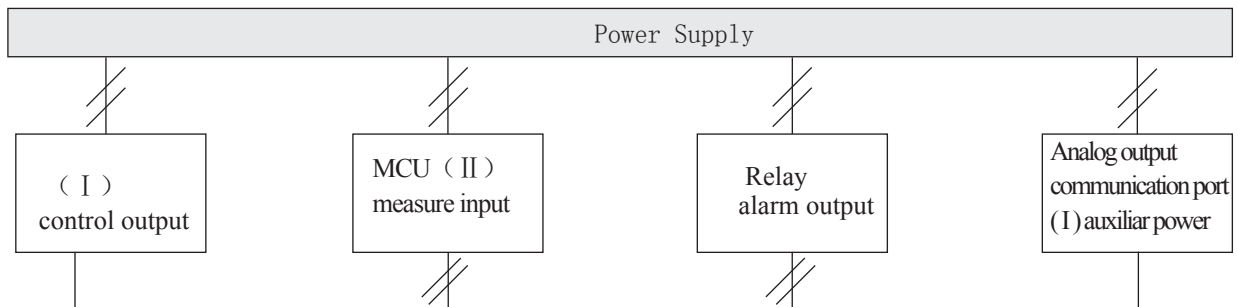

“//”: Isolation

Note: The auxiliary power supply is not fully insulated with communication port, analog output, control output.

## Panel Key Illustration

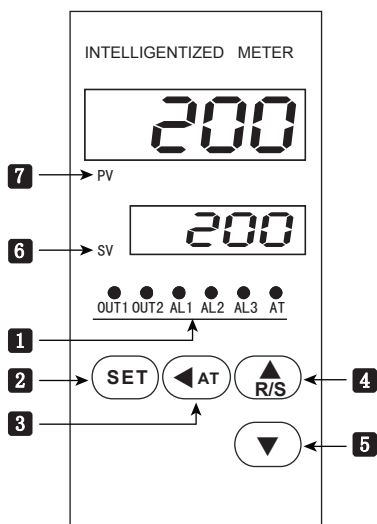

No.	symbol	Name	Function
1	OUT1	out1 indicate light(red)	Main control output indicate light,it lighting when output is ON
	OUT2	out2 indicate light(red)	Cool output indicate light, it is lighting when the output is ON
	AL1	Alarm1 indicate light(red)	1st alarm output indicate light,alarm output with lighting, no alarm output without lighting.
	AL2	Alarm2 indicate light(red)	2nd alarm output indicate light,alarm output with lighting, no alarm output without lighting.
	AL3	Alarm3 indicate light	AL3: This product do not have alarm3 function
	AT	AT indicate light(green)	Auto-tuning indicate light, it indicates the auto-tuning status when lighting on.
2	SET	SET function key	menu key/confirm key, to enter or exit modified mode or confirm modified parameter
3	◀ AT	Shift/AT key	Activation key/shift key/AT auto-tuning key,long press to enter or exit auto tuning under the measure control mode.
4	▲ R/S	Increase key/R/S	Increase key, long press it can realise to shift RUN/STOP mode under measure control mode.
5	▼	Reduce key	Reduce key
6	SV	Display window (green)	Setting value/parameters display window,display “STP”=stop control
7	PV	Display window (red)	measured value/parameters code display window

Note: 36H\*72Wmm size OUT1 and OUT2 indicate light is green



5	D	Differential time,reduce the effect of differential time to a proper value,which can prevent the system oscillation. The higher value,the stronger function of differential.Unit:s	0~999	30
6	SPD	Control speed fine tuning,optional 0(N)no function,1(slow),2(ss)medium fast, 3 (SSS) very slow, 4 (F) fast, 5 (FF) medium fast, 6 (FFF) express	0~6	N
7	OVS	Overshoot limit,in the process of PID control,when PV>SV+OVS,it force off output; The lower value,the lower PID adjusted range,the worse control stability;please set a proper value according actual state.	0~999	5
8	DB	On-off control backlash(negative backlash on-off control)or cooling control and compressor cooling control dead zone. please change the value according to decimal position, when changing input signal type.	0~100	10
9	CP	OUT1 control cycle,1:SSR control output,4-200:relay control output. Unit:second	1~200	20
10	CP1	OUT2 control cycle,cooling relay output cycle. Unit:second	4~200	20
11	PC	OUT2 cooling proportionality coefficient,the higher of value,the stronger of cooling	1~100	10.0
12	AL1	1st alarm value,note:the minus is dealt with as absolute value when it is as a deviation value .	FL~FH	200
13	HY1	1st alarm backlash value	0~1000	1
14	AD1 (1)	1st alarm type,note:the value should set 0 when 1st alarm is as OUT2; Set AD2 to 0 when actting value>6.Otherwise it will close alarm function when it is 0.	0~12	1
15	AL2	2nd alarm value,note:the minus is dealt as absolute value when it is as a deviation value .	FL~FH	600
16	HY2	2nd alarm backlash value	0~100	1
17	AD2 (1)	2nd alarm type,note:the value should set 0 to close alarm function when the AD1>6.	0~6	2
18	PS	Amend value,display value=actual measured value+amend value	-199~999	0
19	INP	Optional input signal type:refer to input signal parameters table. Note: Do not forget to change the relevant parameters after changing input signal.	0~10	0
20	OT	Control type,0:ON/OFF control;1:PID heating control; 2:compressor cooling control; 3:PID heating& cooling control ( set the AD1 as 0, then OUT2 can be acted to realise PID heating and cooling control)	0~3	1
21	LCK	Lock function;0001:SV value can not be changed;0010:menu setting value only can be checked but cannot be modified. It can enter project menu with 0033 in the process of checking menu.	0~999	0
22	ACT	Control execution type,0:relay/SSR output;1:single SSR output control (the product reserve this function) 2: 4~20mA output control please set according to selected meter 3:TF3,TF4, TF7 can set the value as 3 to change 4-20mA control output to analog output	0~2/0~3	0
23	FL	Measure range low limit,the setting value must be less than measure range high limit	Refer to measured signal parameter table	-50
24	FH	Measure range high limit,the setting value must be more than measure range low limit.	Refer to measured signal parameter table	999
25	BRL	Analog range low limit, note: When the value is larger than analog output high limit, the analog output is reverse .	moreFH	-50
26	BRH	Analog range high limit, note: when the value is less than analog output low limit, the analog output is reverse.	FL~FH	999
27	OLL	Output low limit,limit the output low limit current amplitude.Setting value must be less than high limit setting	-5~100	0
28	OLH	Output high limit,limit the output high limit current amplitude.Setting value must be more than low limit setting	0~105	100
29	BAD	RS485 communication baud rate 0 (4.8) : 4800; 1 (9.6) : 9600	0 (4.8) , 1 (9.6)	9.6
30	ADD	Communication ADD	0~255	1
31	DTC	Sequenced transport of communication data and setting 000 of respon relay; 1st is function reserve,2nd is byte. Sequenced exchange,3rd is respon relay,it can set 0~9 to 10~100ms.	Refer to communication procotol note②	0
32	FT	PV filter coefficient of digital filter,the higher of value,the stronger of filter function	0~255	10

33	UT	Temperature unit: °C : Celsius degree °F : Fahrenheit degree Fahrenheit,note:the unit is only for temperature measure signal.	25 (°C) 26 (°F)	25 (°C)
34	AE1(2)	1st alarm expansion	0~5	0
35	AE2(2)	2nd alarm expansion	0~5	0
36	PT	Compressor starting delay time,unit:s	0~999	180
37	PDC	Optional PID type 0(FUZ): Advanced fuzzy PID arithmetic; 1(FCT):Single prediction PID arithmetic; 2(STD): normal PID arithmetic	0~2	FUZ
38	DP	Decimal point setting, it is available for linear signal input	0~3	0
39	DTR	PV fuzzy tracking value,it can get a stable control display value in some place where is suitable to set the value. The value is unrelated with actual measured value.Note:when the alarm setting value is equal with SV setting value after setting the value,operation of alarm output will subject to actual measured value.Setting 0 to close the function.Temperature unit: °F/°C Line signal input unit:engineering work Digits	0.0~2.0	1.5
40	CAE	User auto-calibrating enable function,this parameter is only for use of input signal expect TC/RTD;Y:user of enable auto-calibrating parameters N:user who don't use enable auto-calibrating parameters	0 (N) , 1 (Y)	N
41	CAL	Operation of user auto-calibrating low limit input,it is starting,when the YES flash after signal input add the low-side signal. It can calibrate input signal low-side when it display OK after entering.	YES/OK	YES
42	CAH	Operation of user auto-calibrating low limit input,it is starting,when the YES flash after signal input add the high-side signal. It can calibrate input signal high-side when it display OK after entering.	YES/OK	YES

(1) Alarm parameters and output logic diagram:

Symbol description: “☆” means HY, “▲” means alarm value, “△” means SV value

No.	Type	Alarm output (AL1、AL2 is independent of each) Image: the hatched section means the alarm action
1	High limit absolute value alarm	
2	Low limit absolute value alarm	
3	※High limit deviation value alarm	
4	※Low limit deviation value alarm	
5	※High/low limit deviation value alarm	
6	※High/low limit interval value alarm	

No.	Type	The following two sets of alarm parameters(AL1、AL2) used in combination,AL1 alarm output,AD2 must set to 0
7	High/low limit absolute value alarm	
8	※High/low limit deviation value alarm	
9	※Alarm between high limit absolute value and low limit deviation value .	
10	※Alarm between high limit deviation value and low limit absolute value.	
11	High/low absolute value alarm	
12	※High/low limit deviation alarm	

※When the alarm value with deviation alarm set to a negative number,it will deal with it as an absolute value.



(2) .Alarm expansion function table

AE1/AE2 value	Alarm handling mode when show HHHH/LLLL	Remark
0	The state when alarm keep HHH/LLL in previous time	Power on alarm, alarm does not inhibit (As long as meet the requirement of alarm , make alarm output)
1	Forced alarm output	
2	Forced alarm close	
3	The state when alarm keep HHH/LLL in previous time	Power on alarm , alarm inhibits. (Before PV value reach the set value at the first time , the alarm does not output)
4	Forced alarm output	
5	Forced alarm close	

Operation of key function

1. Monitoring mode operation

- 1) Under the measure mode,press“ $\blacktriangle$ ”into monitoring mode;and on the SV window display“STP”.Press“ $\blacktriangle$ ”to back.
- 2) It can alter SV value and switch operation event displaying STP.
- 3) Under the monitoring mode,host control output will stop or set min output except alarm output and analog output.

2. PID Parameter identification and auto-tuning operation:

- 1) The factory default PID parameters usually does not apply to use occasion;please using auto-tuning function to get a suitable PID parameter.
- 2) The meter will enter control output since the power input, now,you can set the monitoring mode to avoid to affect the effect of auto-tuning function,or switch off the power of control output load.No matter how to operate, it should guarantee the set value greater than the current measured value and drop the bigger the better.
- 3) In order to avoid the effect deu to alarm interlocking output,please set the proper alarm value,or remove the alarm effect.
- 4) Set PID type and SV value;the factory default is PID with fuzzy.
- 5) Set to PID control,please set the output to a proper range if it has OLL & OLH output limit;factory default is OLL=0%,OLH=100%.
- 6) Under the condition of PV value at normal room temperature,please back to monitoring mode or input the load power,and long press “AT” enter auto-tuning mode,now,AT indicator will shine.
- 7) Auto-tuning will take the time,in order not to affect auto-tuning result,please don't change the parameters or power-off.
- 8) PID parameters will auto update when AT light is out and auto back auto-tuning mode.This monment,it will auto control exactly.
- 9) It will abort the auto-tuning when you long press “AT”key,measure beyond the scope,display abnormally,swith to “STP”,power-off in the process of auto-tuning.
- 10) NoteIn the place with output limit,it can't get the best PID parameters event with the auto-tuning.
- 11) You can set a proper PID parameter with your rich experience.

3.PID & Cooling control operation

- 1) PID control act on host control output OUT1; Cooling control act on OUT2.
- 2) AL1 alarm function & OUT2 can reuse,please set AD1 to 0 when using the cooling control;but the 1st alarm function can't work after setting.
- 3) Please set the control type OT to 3.
- 4) Please set the cooling start offset to a value great than 5,to ensure the cooling would not affect the PID control impact.
- 5) Please change the cooling control cycle to a proper value,and change the cooling scaling factor to a a proper value.
- 6) When PV value > SV+DB value,the cooling control start to effect;the bigger value of PV,the longer output time of OUT2.

4.Signal linear auto-tuning function operation

- 1) Set up the INP type,and ensure one of inputs(0~50mV、RT(0~400Ω)、4~20mA and 0~10V)
- 2) Add the input signal to a proper input channel.
- 3) Enter menu low-limit to calibrate CAL,press “AT”to flash”YES”;and set the input signal to min value and input to meter.
- 4) When “YES”is flashing,and the min value of signal has input to meter,please press “SET”to ensure and save the calibrating value.
- 5) After calibrating low-limit,enter the high limit to calibrate CAH in menu,and flash “YES”.
- 6) Set the input signal to max value to meter,and press “SET”to ensure and save the calibrating value when the “YES”is flashing.
- 7) After calibrating,it can enter CAE,and change “N”to “Y”then it can use calibrating value,or it will use the factory default value.
- 8) The linear signal value of high-limit input should not great than the inout standard value range  $\pm 10\%$ .
- 9) If you're not satisfied with the calibrating result,you can reset.

Dimension

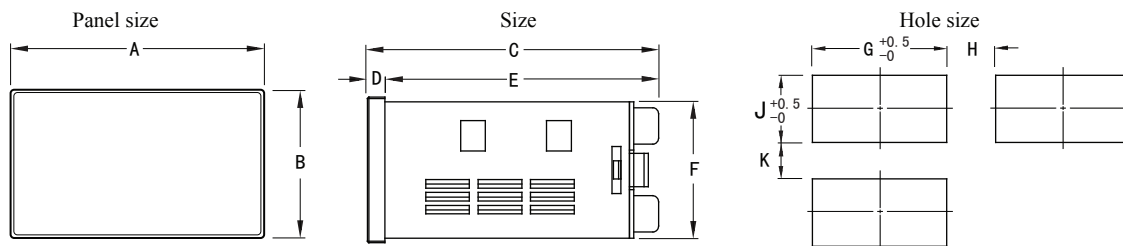

Size	A	B	C	D	E	F	G	H (Min)	J	K (Min)
3: (72*36)	72	36	70.5	6.5	64	32	68	25	33	25
4: (48*48)	48	48	101	10	91	45	45.5	25	45.5	25
6: (96*48)	48	96	100	6	94	91	45.5	25	91.5	25
7: (72*72)	72	72	100	10	90	67.5	68	25	68	25
8: (48*96)	96	48	100	6	94	45	91.5	25	45.5	25
9: (96*96)	96	96	100	10	91	90.5	91	25	91	25
80: (80*160)	160	80	102	10	92	76	154	30	76.5	30
16: (160*80)	80	160	102	10	92	153.5	76.5	30	154	30

# Connections

TF3

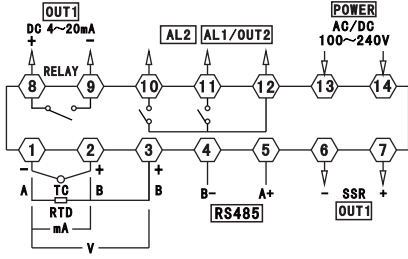

TF4

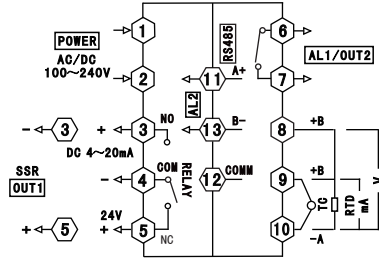

TF6

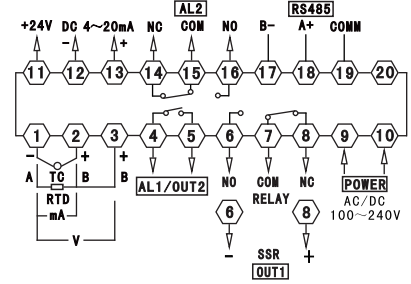

TF7

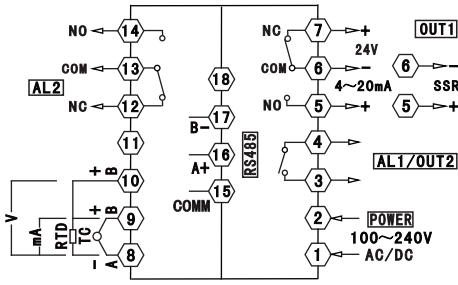

TF8

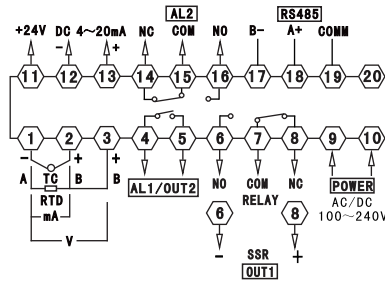

TF9

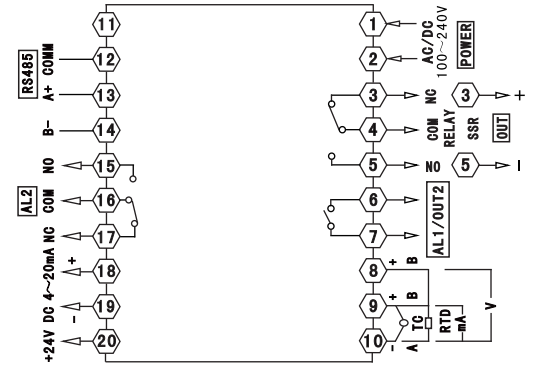

Note: If there is any change, please subject to the drawing on the meter

## Methods of simple fault

Display	Methods
LLL/HHH	Checks whether the input disconnection and whether normal of FH value, FL value, working environment temperature and whether collect of input signal.