

CG-X Series Digital Counter User Manual



Features:

- Dual line 6 digits LED display
- Optional dimension: 48W×48H、96W×48H、72W×72H
- Can work with incremental rotary encoder, realize count up and count down, bi-directional counting function.
- One preset value alarm relay output.
- Manual reset, auto reset, key lock function, power failure memory function.
- Settable counting coefficient, NPN or PNP input selectable.
- Widely applied to the industries relevant to timber machining, food machinery, packing machinery, steel machining, etc.

I. Model Illustration

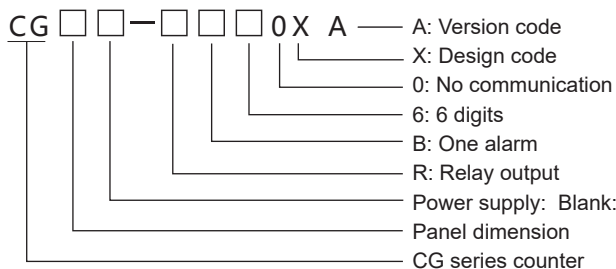

Model	Dimension(mm)	Digits	Alarm output	Power supply
CG4-RB60X	48W×48H×97.5L	6	1 relay output	AC/DC
CG7-RB60X	72W×72H×97.5L	6	1 relay output	100 ~ 240V
CG8-RB60X	96W×48H×97.5L	6	1 relay output	50/60Hz

II. Technical Parameter

Power Supply	AC/DC 100 ~ 240V 50/60Hz
Total Power Consumption	≤4W
Relay Capacity	AC 250V/3A
Output Voltage	DC 12V±5V(≤25mA)
Insulation Resistance	≥20MΩ
Insulation Strength	AC 2kV
Anti-interference	Power:3000Vp-p、 I/O terminal:1000Vp-p
Input Signal (sine wave, square wave)	Signal Level: Hight:3 ~ 30V Low:0 ~ 2V
Counting Input Speed	≤1/30/300/5000Hz(4 speed selectable)
Counting Range	-199999 ~ 999999
Delay Time	0.01 ~ 499.99s
Coefficient Setting Range	0.00001 ~ 999999
External Signal	External reset frequency 1ms, 20ms selectable

III. Panel Illustration

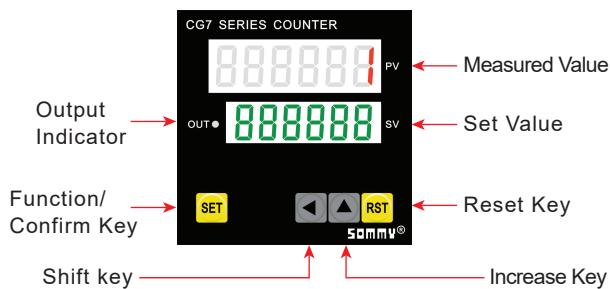

- SET: In measuring state, press SET key 3 sec to enter setting state.
- RST: In measuring state, press it to reset PV.
- ▲ : In setting state, press it to add 1 to the flashing digit.
- ◀ : In measuring state, press it to enter SV modification state; in setting state, press it to move the flashing digit one position to the left.
- Note: In setting state, press SET key 3 sec to save the current setting and return back to measuring state; in setting state, if there is no operation for long time, meter will automatically return back to measuring state (set parameter is not saved.)

IV. Dimension & Wire Connection

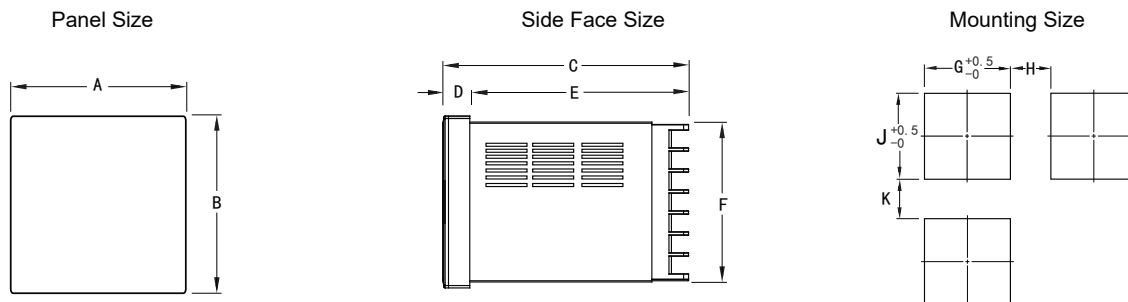

Model	A	B	C	D	E	F	G	H(Min)	J	K(Min)
4:(48×48)	48	48	97.5	6.5	91.0	45	45.5	25	45.5	25
7:(72×72)	72	72	97.5	9.0	88.5	67	67.5	25	67.5	25
8:(48×96)	96	48	97.5	9.0	88.5	44.5	92	25	45	25
Remark	Unit: (mm) tolerance +0.5% (unless there is special specific illustration)									

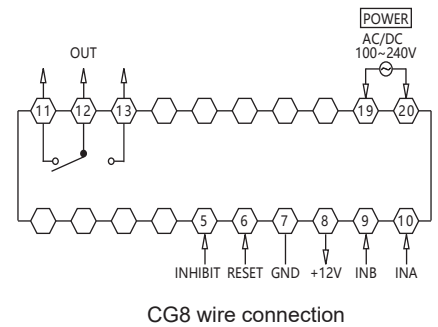
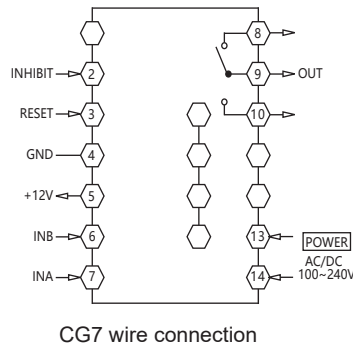
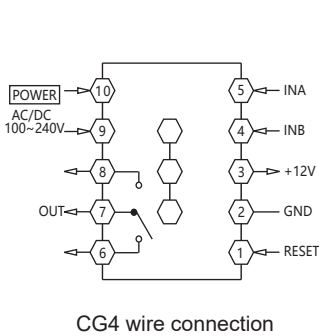

Note: If there is any change, please subject to the drawing on the meter.

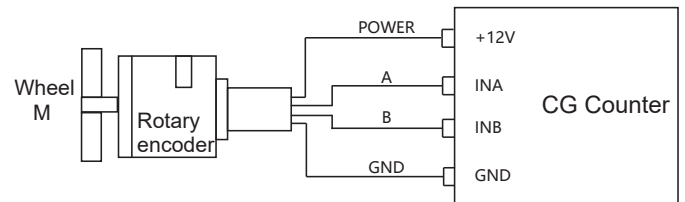
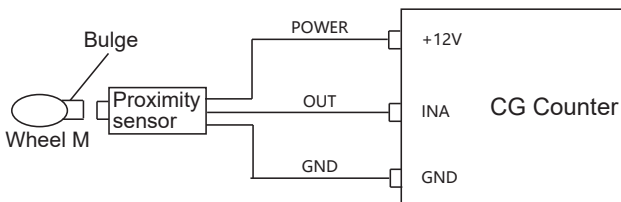

V. Operation process

Measuring state

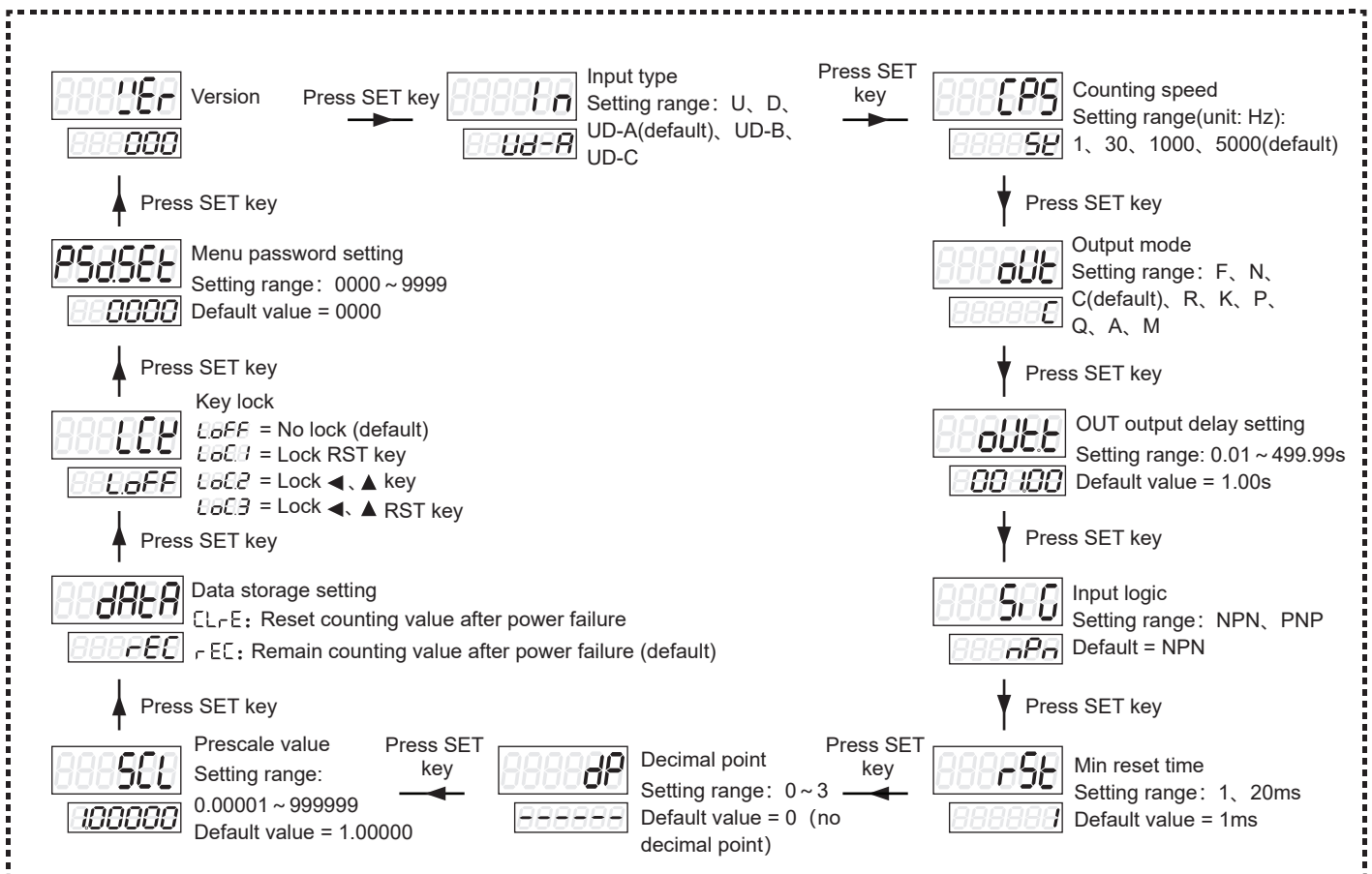
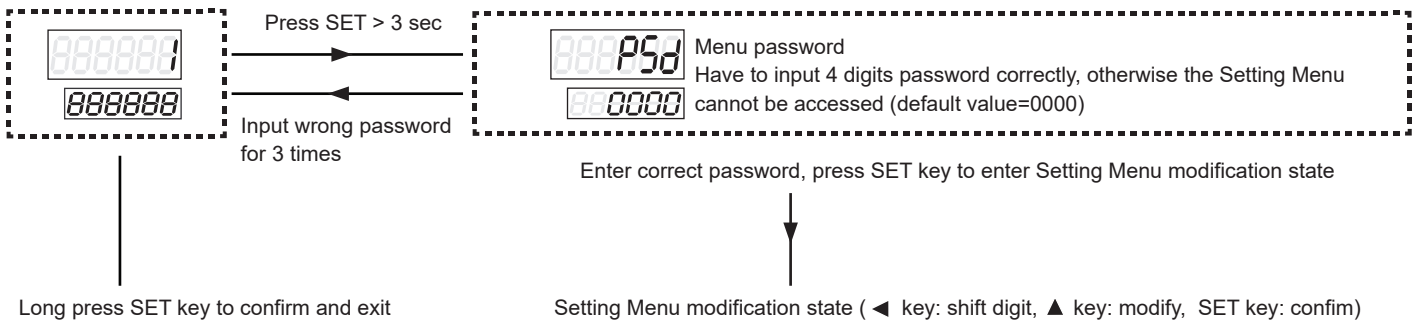

VI. Counter Meter Input Active Mode



※(A): > minimum signal width (B): > 1/2 minimum signal width

Input type	Illustration	Note
U (Add)		INA: Counting Input INB: Control Input INB=L: INA pulse input add count INB=H: INA forbid to count
		INA: Control Input INB: Counting Input INA=H: INB pulse input add count INA=L: INB forbid to count
D (Minus)		INA: Counting Input INB: Control Input INB=L: INA pulse input minus count INB=H: INA forbid to count
		INA: Control Input INB: Counting Input INA=H: INB pulse input minus count INA=L: INB forbid to count
UD-A (Add/ Minus-A) Order Input		INA: Counting Input INB: Control Input INB=L: INA pulse input add count INB=H: INA pulse input minus counting
UD-B (Add/Minus-B) Sole Input		INA input pulse, add count INB input pulse, minus count
UD-C Phase Difference Input		INA before, INB add count INA delay, INB minus count Phase difference input (for rotary encoder)

※ When using rotary encoder's A, B phase output, please connect meter's INA, INB input terminal, and set the input mode as UD-C.

Symbol \ Input Type	Voltage Input (PNP)	Terminal Input (NPN)
H	DC 5-30V	Short Circuit
L	DC 0-2V	Open Circuit

VII. Output Operation Mode For Counter

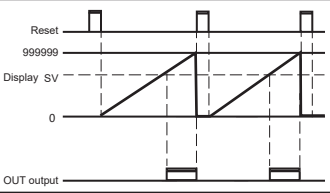
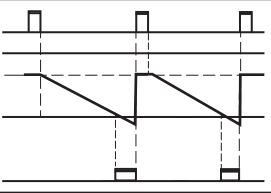
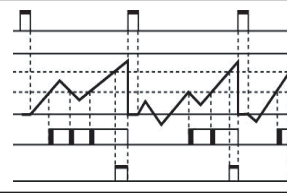
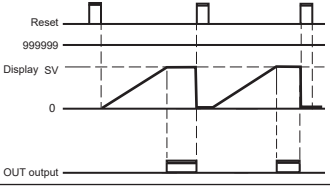
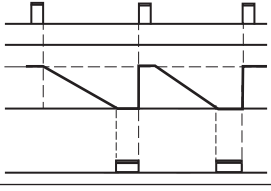
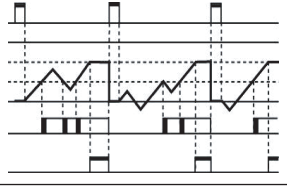
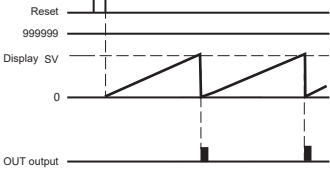
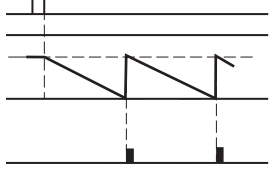
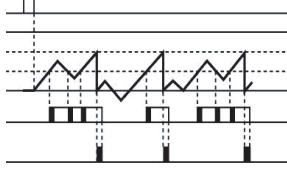
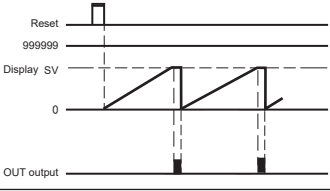
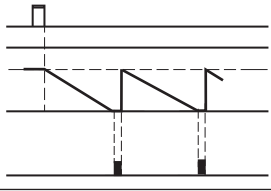
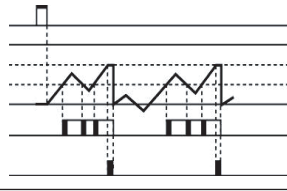
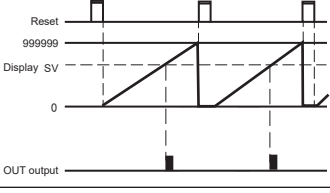
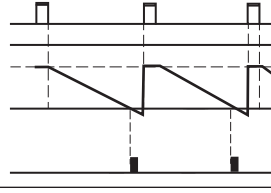
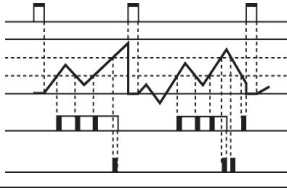
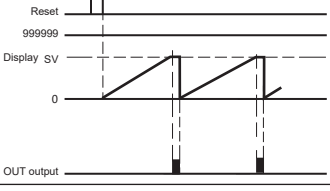
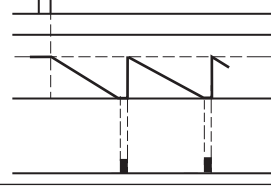
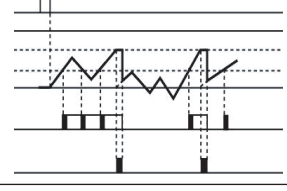
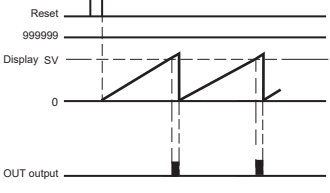
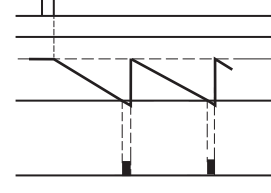
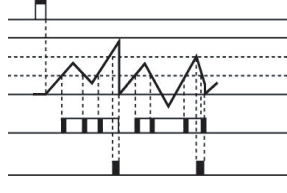
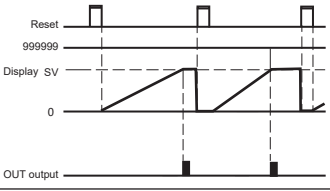
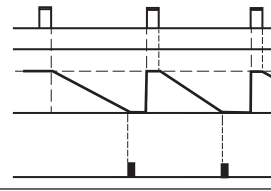
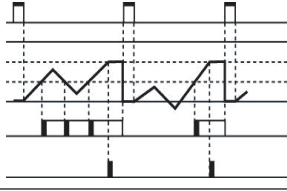
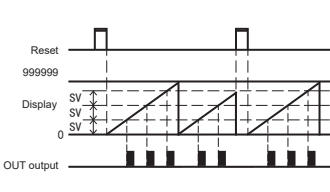
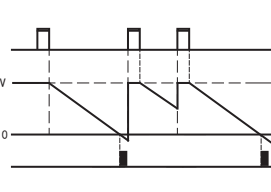
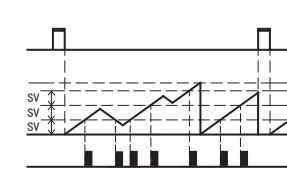
		 One-shot Output	 Hold Output	 Simultaneous Output	
		Input Mode			Operation after reached the SV
		Up	Down	Up/DownA,B,C	
F				Display will continue to increase or decrease, output will be kept until the reset input	
N				Display and output will be kept until the reset input	
C				Display value will return to the start status automatically, output delay will return to the initial status after reached the setting time. (Output activity is repeat single output)	
R				Display value and output will automatically return to the initial status after keep to the delay setting time. (Output activity is repeat single output)	
K				Display value will continue to increase or decrease until reset input, output delay will return to the initial status after reached the setting time. (Output activity is repeat single output)	
P				Display value will be kept until the delay time, will display the next cycle. (In the delay time, the next cycle counting and timing from initial status) (Output activity is repeat single output)	
Q				Display value will continue to increase or decrease within output delay time, display value and output will return to the initial status after output delay reached the setting time. (Output activity is repeat single output)	
A				Display value will be kept until the reset input, OUT output will return to the initial status after reaching the setting time. (Output activity is repeat single output)	
M				When display value=an integral multiple of SV, OUT output will automatically return to the initial status after reaching the setting time. Display value will keep accumulating, when display value is greater than the maximum display value, it will automatically overflow.	