

# Intelligent Temperature Controller

## User Manual

Suitable for TF-E version series



### Features

- Optional input signal types and models
- With functions of measurement display, control output, alarm output, analog output, RS485 communication, etc.
- Different types of PID arithmetic and with auto-tuning function.
- Optional PID heating and cooling function (refer to OT parameter)
- Manual/automatic control switch (refer to A-M parameter)
- This product is used in industrial machinery, machine tools, general measuring instruments and equipment.
- Economy and easy operation.

National High-tech Enterprise/ National Standard Drafting Unit



Service Hotline: 400-8866-986

Version : KKTf-E01E-A / 0-20200527

The instruction explain instrument set, connections,name and etc, please read carefully before using the temperature controller. Please keep it properly for necessary reference.

### I. Safety Caution

#### ⚠ Warning

- 1) When the failure or abnormal of products lead to a system of major accidents, please set the proper protection circuit in the external.
- 2) Please don't plug in before completing wire connection. Otherwise it may cause electric shock, fire, fault.
- 3) Do not use outside the scope of product specification, otherwise it may lead to fire, fault.
- 4) Not allow to use in the place where is inflammable and explosive gas.
- 5) Do not touch power terminal and other high voltage part when the power on, otherwise you may get an electric-shock.
- 6) Do not repair or modify the product, otherwise it may cause electric shock, fire, fault.

#### ⚠ Warning

- 1) The product should not be used in a nuclear facility and human life associated medical equipment.
- 2) The product may occur radio interference when it used at home. You should take adequate countermeasures.
- 3) The product get an electric shock protection through reinforced Insulation. when the product is embedded in the devices and wiring, please subject to the specification of embedded devices.
- 4) In order to prevent surge occurs, when using the product in the place of over 30m indoor wiring and wiring in outdoor, you need to set the proper surge suppression circuitry.
- 5) The product is produced based on mounting on the disk. In order to avoid to touch the wire connectors, please take the necessary measures on the product
- 6) Be sure to observe the precautions in this manual, otherwise there is a risk of a major injury or accident.
- 7) When wiring, please observe the local regulation.
- 8) To prevent to damage the machine, the product is connected with power lines or large capacity input and output lines and other methods, install proper capacity fuse or other methods of protection circuit.
- 9) Don't put metal and wire clastic mixed with the product, otherwise it may cause electric shock, fault.
- 10) Please tighten screw torque according to the rules. If not, it may lead to electric shock and fire.
- 11) In order to not interfere the products to dissipate heat, don't plug casing around the cooling vent hole and equipment.
- 12) Please don't connect any unused terminal.
- 13) Please do the cleaning after power off, and use the dry clean cloth to wipe away the dirt. Don't use desiccant, otherwise, it may casue the deformation or discoloration of the product.
- 14) Please don't knock or rub the panel with rigid thing.
- 15) User should have basic knowledge of electrical, control, computer and communications.
- 16) The illustration, example of data and screen in this manual is convenient to understand, instead of guaranteeing the result of the operation.
- 17) In order to use the product with safety for long-term, regular maintenance is necessary. The lifetime of some parts have some restrictions, but the performance of some will change for using many years.
- 18) Without prior notice, the manual may change. If you have questions or objections, please contact us.

#### ⚠ Caution of Install & Connection

##### 1. Installation :

- 1) This product is used in the following environmental standards.  
( IEC61010-1 ) [Overvoltage category II、 class of pollution 2]
- 2) The product is used in the following scope: surrounding environment, temperature, humidity and environmental conditions. Temperature : 0 ~ 50°C; Humidity : 45 ~ 85%RH; Environment condition : Indoor warranty, The altitude is less than 2000m.

### 3) Please avoid using in the following places:

Places where condensation may occur due to dramatic temperature changes; or where corrosive or flammable gases are generated; direct vibration or potential vibration impacting the product. Place with water, oil, chemicals, smoke, and steam, lot of dust, salt, and metal powder, clutter interference is large. Places with magnetic field or noise; The place where the airflow of the air conditioner or the heater blows directly, place with direct sunlight irradiated; the place where heat may be accumulated due to radiation, etc.

### 4) On the occasion of the installation, please consider the following before installation.

In order to protect heat saturated, please ensure adequate ventilation space. Please consider connections, and ensure that the products have more than 50mm space. Do not installed over the machine of the calorific value (Such as heaters, transformer, semiconductor operations, the bulk resistance). When the surrounding is more than 50°C, use force fan or cooling fans. But don't let cold air blowing directly to the product.

To improve anti-interference performance and security, stay away from high voltage machines.

Don't install on the same plate with high voltage machine and the product.

The distance should be more than 200mm between the product and power line.

#### 2. Cable caution :

- 1) Please use specified compensation wire for TC input; use insulated TC for heated metal.
- 2) Please use the cable of lesser resistance for RTD input, and the cable (3 wire) must be no resistance difference, and the total length is within 5m.
- 3) To avoid noise, put input signal away from meter cable, power cable, load cable to wiring.
- 4) To reduce the power cables and the load power cables on the effect of this product, please use noise filter. Do install it on the grounding of the disk if you use the noise filter; and make the wiring to be shortest between noise filter output side and power connectors. Don't install fuse and switch on noise filter output side, otherwise it may affect the result.
- 5) It takes 5s from input to output. If need interlocking actions of signal, please use timer relay.
- 6) Please use twisted pair with a shield for remote RS485 communication cable, and deal with the shield on the host side earth, to ensure the reliability of signal.
- 7) Please use twisted pair with a shield for remote RS485 communication cable, and deal with the shield on the host side earth, to ensure the reliability of signal.
- 8) The product don't have fuse; please set according to rated voltage 250V, rated current 1A if you need; fuse type: relay fuse.
- 9) Please use the suitable screw force and crimp terminal. The screw terminal size : M3X8 (with 7.0X7.0 square base) Recommended tightening torque : 0.4N.m  
Proper cables : 0.25 ~ 1.65mm single cable/multiple core cable
- 10) Don't put the Crimp terminal or bare wire part contact with adjacent connector.

### II. Model Illustration

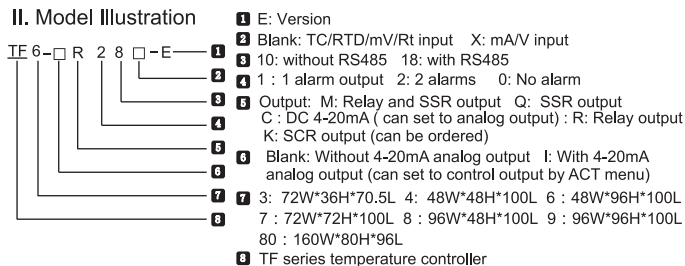

Please note input signal type when choosing model. 1st type: TC/RTD/mV/Rt ; 2nd type: mV/A.

There is only one 4 ~ 20mA output for the whole series meters. In size of 6, 8, 9, when the relay output, srr output exist together with 4-20mA output. "I" used to distinguish. Such as IR, IQ ect. But for 3, 4, 7 size, it does have this kind of model.

### III. Common Model Selection

No.	Model	OUT1 control output		alarm output		analog output	Comm.	Auxiliary power
		RELAY	SSR	AL1 OUT2	AL2	4 ~ 20mA	RS485	24V
1	TF3-IQ28□		●	●	●	◎	●	
2	TF3-IQ2□		●	●	●	◎		
3	TF3-M28□	●	●	●	●		●	
4	TF3-M2□	●	●	●	●			
5	TF3-M1□	●	●	●	●			
6	TF4-C2□		●	●	●	◎		●
7	TF4-C18□		●	●	●	◎	●	●
8	TF4-Q2□		●	●	●			
9	TF4-Q18□		●	●	●		●	
10	TF4-R2□	●		●	●			
11	TF4-R18□	●		●	●		●	
12	TF4-M1□	●	●	●	●			
13	TF7-C28□		●	●	●	◎	●	●
14	TF7-C2□		●	●	●	◎		●
15	TF7-Q28□		●	●	●		●	
16	TF7-R28□	●		●	●		●	
17	TF7-M2□	●	●	●	●			
18	TF7-M1□	●	●	●	●			
19	TF6/8/9/80-C28□		●	●	●	◎	●	●
20	TF6/8/9/80-C2□		●	●	●	◎		●
21	TF6/8/9/80-IR28□	●	●	●	●	◎	●	●
22	TF6/8/8/80-IR2□	●	●	●	●	◎		●
23	TF6/8/9/80-R28□	●		●	●		●	
24	TF6/8/9/80-IQ28□		●	●	●	◎	●	●
25	TF6/8/9/80-IQ2□		●	●	●	◎		●
26	TF6/8/9/80-Q28□		●	●	●		●	
27	TF6/8/9/80-M2□	●	●	●	●			
28	TF6/8/9/80-M1□	●	●	●	●			

□ : Blank: input signal is TC/RTD/Mv/Rt; "X" : input signal is 4 ~ 20mA/0 ~ 10V

● : Standard configuration function

◎ : The meter has this function, but it is combined with another function. The meter only have one 4~20mA output, and user can set ACT menu as main control output or analog output.

# IV. Main Specifications

## 1. Electrical parameters:

Sample rate	2 times per second
Relay capacity	AC 250V /3A Life of rated load>100,000 times
Power supply	AC/DC 100 ~ 240V ( 85~265V )
Power consumption	< 6VA
Environment	Indoor use only, temperature: 0~50°C no condensation, humidity < 85%RH, altitude<2000m
Storage environment	-10 ~ 60°C, no condensation
SSR output	DC 24V pulse voltage, load<30mA
Current output	DC 4 ~ 20mA load<500Ω, temperature drift 250PPM
Communication port	RS485 port Modbus-RTU protocol, max input 30 units
Insulation impedance	Input, output, power VS meter cover > 20MΩ
ESD	IEC/EN61000-4-2 Contact ±4KV /Air ±8KV perf.Criteria B
Pulse trap anti-interference	IEC/EN61000-4-4 ±2KV perf.Criteria B
Surge immunity	IEC/EN61000-4-5 ±2KV perf.Criteria B
Voltage drop & short interruption immunity	IEC/EN61000-4-29 0% ~ 70% perf.Criteria B
Isolation voltage	Signal input, output, power: 1500VAC 1min , <60V low voltage circuit: DC500V , 1min
Total weight	About 400g
Cover material	The shell and panel frame PC/ABS (Flame Class UL94V-0)
Panel material	PET(F150/F200)
Power failure memory	10 years, times of writing: 1 million times
Panel Protection level	IP65(IEC60529)
Safety Standard	IEC61010-1 Overvoltage category II , pollution level 2 , levelII( Enhanced insulation )

## 2. Measured signal specifications :

Input type	Symbol	Measure range	Resolution	Accuracy	Input impedance /auxiliary current	Com. parm. code
K	℄	-50 ~ 1200	1°C	0.5%F.S±3digits	> 500kΩ	0
J	℄	0 ~ 1200	1°C	0.5%F.S±3digits	> 500kΩ	1
E	℄	0 ~ 850	1°C	0.5%F.S±3digits	> 500kΩ	2
T	℄	-50 ~ 400	1°C	0.5%F.S±3°C	> 500kΩ	3
B	℄	250 ~ 1800	2°C	1%F.S±2°C	> 500kΩ	4
R	℄	-10 ~ 1700	1°C	1%F.S±2°C	> 500kΩ	5
S	℄	-10 ~ 1600	1°C	1%F.S±2°C	> 500kΩ	6
N	℄	-50 ~ 1200	1°C	0.5%F.S±1°C	> 500kΩ	7
PT100	℄	-200 ~ 600	0.2°C	0.5%F.S±0.3°C	0.2mA	8
JPT100	℄	-200 ~ 500	0.2°C	0.5%F.S±0.3°C	0.2mA	9
CU50	℄	-50 ~ 150	0.2°C	0.5%F.S±3°C	0.2mA	10
CU100	℄	-50 ~ 150	0.2°C	0.5%F.S±1°C	0.2mA	11
0 ~ 50mV	℄	-1999 ~ 9999	12bit	0.5%F.S±3digits	> 500kΩ	12
0 ~ 400Ω	℄	-1999 ~ 9999	12bit	0.5%F.S±3digits	0.2mA	13
*4 ~ 20mA	℄	-1999 ~ 9999	12bit	0.5%F.S±3digits	100Ω	14
*0 ~ 10V	℄	-1999 ~ 9999	12bit	0.5%F.S±3digits	> 1MΩ	15

\* Pls indicate the requirement when choose the model.

## 3. Isolation diagram

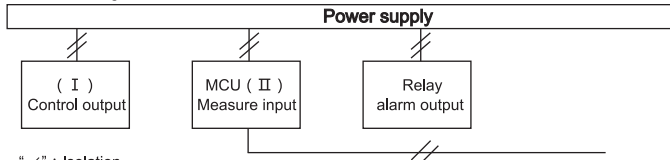

"//": Isolation

Note : When the auxiliary power supply between ( I ) & ( II ) is used as the power supply for external sensor, if the sensor is non-isolated, it does not isolate.

## V. Dimension and installation size

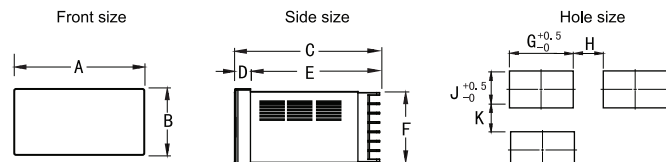

Model	A	B	C	D	E	F	G	H(Min)	J	K(Min)
3:(72*36)	72	36	70.5	6.5	64	32	68	25	33	25
4:(48*48)	48	48	97.5	6.5	91	45	45.5	25	45.5	25
6:(96*48)	48	96	97.5	9	88.5	89.5	45	25	92	25
7:(72*72)	72	72	97.5	9	88.5	67	67.5	25	67.5	25
8:(48*96)	96	48	97.5	9	88.5	44.5	92	25	45	25
9:(96*96)	96	96	97.5	9	88.5	91.5	92	25	92	25
80:(160*80)	160	80	96	13	83	75.5	155.5	30	76	30

## VI. Wire Connections

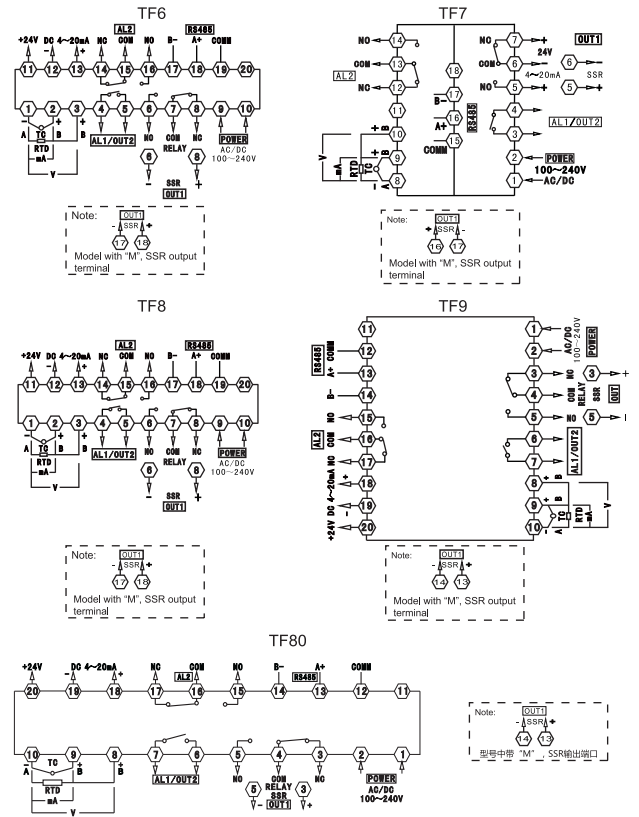
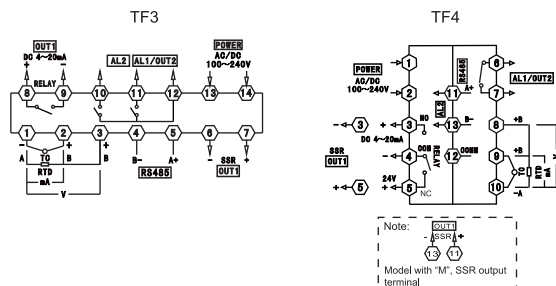

## VII. Panel Illustration

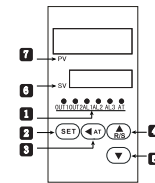

No.	Symbol	Name	Function
1	OUT1	OUT1 (red) *	Main control output indicator, lights on when output ON.
	OUT2	OUT2 (red) *	Cooling output indicator, lights on when output ON.
	AL1	Alarm 1# (red)	1st alarm output indicator, lights on when alarm output, lights off when no alarm output.
	AL2	Alarm 2# (red)	2nd alarm output indicator, lights on when alarm output, lights off when no alarm output.
	AL3	Alarm 3#	AL3: this product does not have this function.
	AT	AT indicator(green)	Auto tune indicator, lights on when it is under auto tune status.
	2	SET	SET key
3	←AT	Shift/AT key	Activate key/ shift key/ AT auto-tuning key (in measure and control mode, long press to enter/exit auto-tuning)
4	↑	Increase key/ R/S	Increase key, long press it to shift RUN/STOP mode under measure control mode.
5	↓	Reduce key	Reduce key, check the menu in sequence
6	SV	Display (green)	Setting value/parameters display window,display "STP" =stop control
7	PV	Display (red)	Measured value/ parameter code display window

\* : Size "3" is green LED.

## VIII. Operation process and menu illustration

### 1. Operation process & method

#### Measure control mode

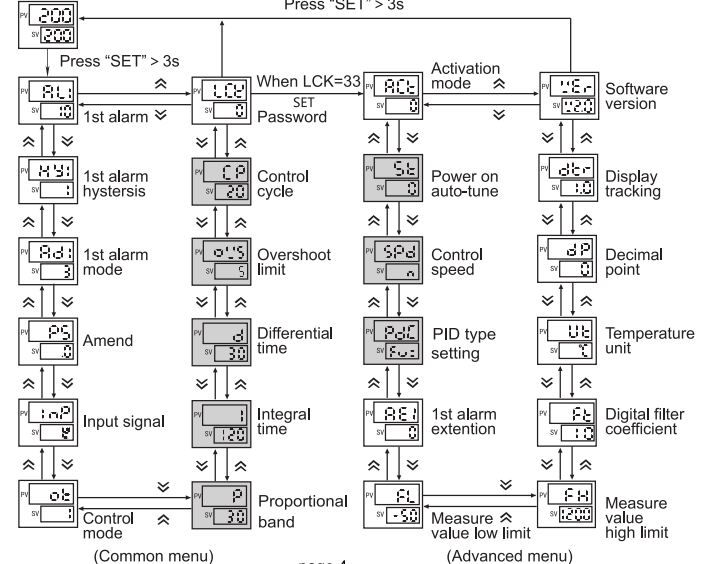

- After power on and under normal measure control mode, long press "SET" key more than 3s to enter the menu parameters checking mode.
- In the menu checking mode, press "SET" key to check the menu parameters circularly.
- In the menu checking mode, short press "←" can flash the current menu parameters to enter the parameter modify mode, and every short press can move one position to the left in cycle.
- In the parameter modifying mode, press "▲" or "▼" key once to add or reduce one of flashing data.
- In the parameter modifying mode, after the modification, press "SET" to save the modified parameter, and exit to menu checking mode.
- In the normal measure control mode, short press "←" to enter SV value modifying status. The way of modifying SV value is same as that of modifying menu parameters.
- In the normal measure control mode, long press "←" more than 3s to enter auto tune state. During auto tune, PV value needs to be lower than SV value.
- In the normal measure control mode, long press "▲" key more than 3s to enter or exit STOP model.

### IX. Menu Illustration

- : Parameters will keep displaying all the time for all the model and all the setting
- : According to different model, control mode, these parameters will be hidden.

#### 1. Regular Menu

No.	Symbol	Name	Illustration	Setting range	Factory setting
1	AL1	AL1	1st alarm value, note: the minus is dealt as absolute value when it is as a deviation value.	FL ~ FH	10
2	HY1	HY1	1st alarm hysteresis	0 ~ 1000	1
3	AD1 (1)	AD1 (1)	1st alarm mode, note: when AL1 is used as OUT2 (cooling output), should set the value AD1=0 (close alarm function). When AD1>6, 2nd alarm function is invalid.	0 ~ 12	3
4	AL2	AL2	2nd alarm value, note: the minus is dealt as absolute value when it is as a deviation value.	FL ~ FH	5
5	HY2	HY2	2nd alarm hysteresis	0 ~ 1000	1
6	AD2 (1)	AD2 (1)	2nd alarm mode	0 ~ 6	4
7	PS	PS	Amend value, display value= actual measured value + amend value	FL ~ FH	0
8	INP	INP	Optional input signal. Note: after selecting the signal, pls properly set below relevant parameters: SV, AL1, HY1, AL2, HY2, P, OVS, DB.	refer to input signal table (page 3)	K
9	OT	OT	Control type : 0, ON/OFF control; related parameter: DB 1, PID heating control, related parameter: P, I, D, OVS, CP, ST, SPD, PDC 2, ON-OFF cooling control, related parameter DB, when used for compressor cooling control, set parameter: PT 3, PID heating & cooling control (cooling control OUT2 make output by AL1 relay, related parameters: P, I, D, OVS, CP, CP1, PC, DB, ST, SPD, PDC 4, Over temperature cooling output, related parameter: DB 5, PID cooling, related parameters: P, I, D, OVS, CP, ST, SPD, PDC	0 ~ 5	1
10	A-M	A-M	Auto-manual control switch : AUTO(0) : auto control output, MAN(1): manual control output, AM(2): manual and auto shift	AUTO~AM	AUTO
11	P	P	Proportional band, the smaller the value is, the faster the system responds, otherwise, it is slower. When P=0, no PID control, unit same as PV	0 ~ 9999	30
12	I	I	Integral time, the smaller the value is, the stronger the integral action is, otherwise, it is weaker. When I=0, no integral action, unit: s.	0 ~ 9999	120
13	D	D	Differential time, the greater the value is, the stronger the differential action is, otherwise, it is weaker. When D=0, no differential action. Set D=0 when controlling fast systems, e.g., pressure, speed; unit: s	0 ~ 9999	30
14	OVS	OVS	Overshoot limit, during PID control process, when PV(measured value) > SV(set value) + OVS (overshoot limit), force to close output. The smaller this value is, the smaller the PID adjustment range is, the worse the control stability is. Please set the appropriate value according to the actual situation.	0 ~ 9999	5
15	CP	CP	OUT1 control cycle, 1: SSR output output, 4-200: relay control output. Unit: s	1 ~ 200	20
16	CP1	CP1	OUT2 relay output cycle. Unit: s	4 ~ 200	20
17	PC	PC	OUT2 cooling proportionality coefficient, the higher of value, the stronger of cooling	1 ~ 100	10
18	DB	DB	ON/OFF control hysteresis(positive and negative numbers work the same); when OT=3, it is the dead zone for cooling control(positive and negative numbers work differently);after change the INP setting, please change this parameter according to the decimal point position.	-1000~1000	5
19	LCK	LCK	Lock function. 0001:SV value can't be modified. 0010: menu setting value only can be checked, can't be modified. 0033: can enter to advanced menu. 0123: menus reset to factory setting.	0~9999	0

#### 2. Advanced menu illustration

No.	Symbol	Name	Illustration	Setting range	Factory setting
20	ACT	ACT	Control output mode, 0:relay output; 1: SSR output control 2 : 4 ~ 20mA control output, please note that for TF3,TF4,TF7 you need to set ACT as 3 to change 4-20mA to analog output.	0~2 (0~3)	0
21	AE1 (2)	AE1 (2)	1st alarm extensions function, refer to alarm extension function table	0~5	0
22	AE2 (2)	AE2 (2)	2nd alarm extensions function, refer to alarm extension function table	0~5	0
23	DP	DP	Decimal point setting, maximum 1 decimal place for TC & RTD input	0~3	0
24	DTR	DTR	PV fuzzy tracking value, properly set this value on some occasions, it can get a more stable control display value, this value is unrelated with actual measured value. Note: after setting this value, when alarm setting value is equal to SV set value, alarm output operation is subject to actual measured value. Set as 0 to close this function.	0.0 ~ 2.0 (0~20)	1.0 (10)
25	FT	FT	Filter coefficient, the higher of value, the stronger of filter function	0 ~ 255	10
26	UT	UT	Temperature unit: °C: Celsius degrees. °F: Fahrenheit degrees. Note: No unit for linear signal	(25)°C (26)°F	(25)°C

No.	Symbol	Name	Illustration	Setting range	Factory setting
27	FL	FL	Measure range low limit, the set value must be less than measure range high limit	Refer to measured signal parameter table	-50
28	FH	FH	Measure range high limit, the setting value must be more than measure range low limit.	Refer to measured signal parameter table	1200
29	BRL	BRL	Analog range low limit, note: when this value is higher than analog range high limit, it is reverse analog output.	FL~FH	-50
30	BRH	BRH	Analog range high limit, note: when this value is lower than analog range low limit, it is reverse analog output.	FL~FH	1200
31	OLL	OLL	Output low limit, limit the output low limit current amplitude. Set value must be less than high limit setting	-5.0~100.0	0
32	OLH	OLH	Output high limit, limit the output high limit current amplitude. Setting value must be greater than low limit setting	0.0 ~ 105.0	100.0
33	ST	ST	Auto-tune activation after power-on, 0: work normally after power-on, 1: automatically enter PID parameters auto-tune status after power-on; long press "←" key to exit auto-tune.	0~1	0
34	SPD	SPD	PID control speed adjustment, option: 0 (N) no function, 1 (s) slow, 2 (ss) medium slow, 3 (SSS) very slow, 4 (F) fast, 5 (FF) medium fast, 6 (FFF) very fast	0~6	N
35	PDC	PDC	PID algorithm option: 0(FUZ): Advanced fuzzy PID arithmetic; 1(STD): normal PID arithmetic	0~1	FUZ
36	PT	PT	Compressor start delay time, unit: s	0~9999	0
37	BAD	BAD	Baud rate 0 (4.8): 4800 ; 1 (9.6): 9600; 2 (19.2): 19200	0~2	9.6
38	ADD	ADD	Communication ADD	0~255	1
39	PRTY	PRTY	Communication parity check setting , 0 : NO 1 : ODD 2 : EVEN	0~2	NO
40	DTC	DTC	Communication data transport sequence 000; 1st bit function reserved; 2nd bit is byte sequence exchange; 3rd bit function reserved.	Refer to COM. protocol note③	0
41	CAE	CAE	User self-calibration enable function, this parameter is only for the input signals except TC/RTD; Y:enable the self-calibration parameters; N: don't use the self-calibration parameters.	0 (N) 1 (Y)	N
42	CAL	CAL	Self-calibration low limit input operation, after adding the low end signal to the signal input terminal, flash YES to activate, after confirm and display OK, the input signal low limit calibration is completed.	YES/OK	YES
43	CAH	CAH	Operation of user auto-calibrating high limit input, it is starting, when the YES flash after signal input add the high-limit signal. It finished calibration of high-limit input signal when it display OK.	YES/OK	YES
44	VER	VER	Software version		

(1) Alarm parameters and output logic diagram:

Symbol description: "▲" means HY, "▲" means alarm value, "△" means SV value

Alarm code	Alarm mode	Alarm output ( AL1 & AL2 are independent from each ) Image:the hatched section means the alarm action
1	High limit absolute value alarm	
2	Low limit absolute value alarm	
3	※High limit deviation value alarm	
4	※Low limit deviation value alarm	
5	※High/low limit deviation value alarm	
6	※High/low limit interval value alarm	

Alarm code	Alarm mode	The below two alarm parameters(AL1,AL2) are used in combination, AL1 alarm output, AD2 must be set as 0
7	High and low limit absolute value interval alarm	
8	※High and low limit deviation value interval alarm	
9	※High limit absolute value and low limit deviation value interval alarm	
10	※High limit deviation value and low limit absolute value interval alarm	
11	High/low limit absolute value alarm	
12	High/low limit deviation value alarm	

※When the alarm value with deviation alarm is set as a negative number, it will be dealt as an absolute value.

### X. Key function operation

#### 1. Stop mode operation

- Under the measure mode, press ▲R/S for several seconds to enter stop mode; and on the SV window display "STOP", main control output will stop or keep at minimum output.
- Under stop mode, short press ▲R/S to exit stop mode, short press "←" to modify SV value.
- Under stop mode, alarm output and analog output can work normally.

#### 2. PID Parameter auto-tuning operation:

- Before auto-tuning, switch off the power supply of control output load at temporary or set the meter as stop mode.
- Before auto-tuning PV value should meet the requirement: PID heating control, PV value is much lower than SV value, PID cooling control, PV value is much larger than SV value.
- Before auto-tuning, set the proper alarm value, or remove the alarm effect to avoid the effect of alarm output.
- Set PID type and SV value; the factory default is PID with fuzzy.
- Set PID control, please set current output to proper range if it has OLL & OLH output limit; default set :OLL=0%,OLH=100%.
- Exit stop mode or connect load power supply, and long press "←" to enter auto-tuning mode, now, AT indicator will flash.

