

EW9 Series 3 Phase Coulometer User's Manual



Features:

- ⊙ To measure: voltage, current, active power, reactive power, frequency, power factor, 4 quadrant energy, etc. Total 28 electrical parameters.
- ⊙ Two On-Off input / output, with remote control and measure function.
- ⊙ Isolation for input / output.
- ⊙ True effective value measuring.
- ⊙ Transformed analog output for voltage, current, active power, reactive power, frequency, power factor.
- ⊙ With RS485 connection and Modbus RTU communication protocol.
- ⊙ With 2 energy pulse output.
- ⊙ With 2 programmable alarm.
- ⊙ To display program setting input parameters.
- ⊙ With power down memory for display menu select / KWH / KvarH.

The coulometers are widely applied to control system, SCADA system and energy management system, transformer substation automation, distributing net automation, small district electrical power monitor, industrial automation, intelligent construction, intelligent switchboard, switch cabinet, etc. It is easy to install and maintain, simple connection, field programmable setting input parameters.

■ Safe Caution

※ For your safe, please read the below content carefully before you use the meter !

Please comply with the below important points:

- ⚠ Warning An accident may happen if the operation does not comply with the instruction.
- ⚠ Notice An operation that does not comply with the instruction may lead to product damage.

※ The instruction of the symbol in the manual is as below:
 ⚠ An accident danger may happen in a special condition.

⚠ Warning

1. A safety protection equipment must be installed or please contact with us for the relative information if the product is used under the circumstance such as nuclear control, medical treatment equipment ,automobile, train, airplane, aviation, entertainment or safety equipment, etc. Otherwise, it may cause serious loss, fire or person injury.
2. Apanel must be installed, otherwise it may cause creepage (leakage).
3. Do not touch wire connectors when the power is on, otherwise you may get an electric shock.
4. Do not dismantle or modify the product, If you have to do so, please contact with us first. Otherwise it may cause electric shock and fire.
5. Please check the connection number while you connect the power supply wire or input signal, otherwise it may cause fire.

⚠ Caution

1. This product cannot be used outdoors. Otherwise the working life of the product will become shorter, or an electric shock accident may happen.
2. When you connect wire to the power input connector or signal input connectors, the moment of the No.20AWG (0.50 mm²) screw tweaked to the connector is 0.74n.m-0.9n.m. Otherwise the connectors may be damaged or get fire.
3. Please comply with the rated specifications. Otherwise it may cause fire after the working life of the product becomes shorter.
4. Do not use water or oil base cleaner to clean the product. Otherwise it may cause electric shock or fire, and damage the product.
5. This product should be avoid working under the circumstance that is flammable, explosive, moist, under sunshine, heat radiation and vibration.
6. In this unit it must not have dust or deposit, otherwise it may cause fire or mechanical malfunction.
7. Do not use gasoline, chemical solvent to clean the cover of the product because such solvent can damage it. Please use some soft cloth with water or alcohol to clean the plastic cover.

1. Model Illustration

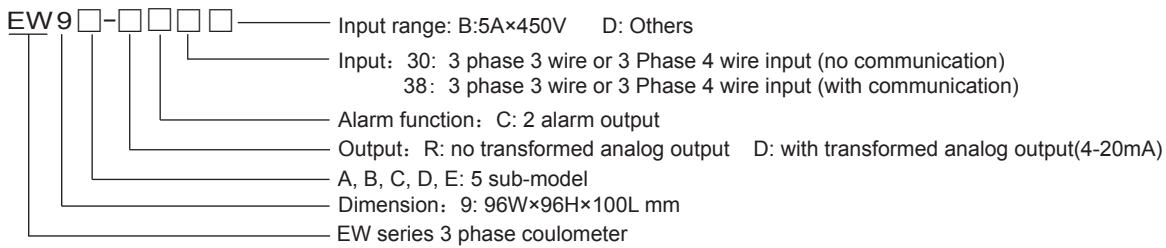

2. Model Indication

Model	Difference	Same function
EW9A-DC38B	display voltage , current , active power ,reactive power KWH, KvarH, frequency, power factor, DIO status.	With 2 programmable setting alarm function, With 1 programmable setting transformed output, With 1 standard RS485 communication, With 1 KWH energy pulse output, With 1 KvarH pulse output. All measured parameters can be read via RS485 standard ports.
EW9B-DC38B	display voltage, current, KWH, DIO status.	
EW9C-DC38B	display voltage, KWH, DIO status.	
EW9D-DC38B	display voltage, KvarH, KWH, DIO status.	
EW9E-DC38B	display voltage, current, active power, reactive power frequency, power factor, DIO status. Additional 8 digit LED to show KWH, KvarH.	

3. Technical Parameters

Connection	3 Phase 3 Wires, 3 Phase 4 Wires
Rated voltage value	AC100V AC450V (Please indicate when order)
Voltage overload	Continuous: 1.2 times Instantaneous: 2 times/10S
Voltage consumption	<1VA (each phase)
Voltage impedance	≥300KΩ
Voltage accuracy	RMS measure, accuracy class 0.5
Rated current value	AC 3A AC 5A (Please indicate when order)
Current overload	Continuous: 1.2 times Instantaneous: 10 times/10S
Current consumption	<0.4VA (each phase)
Current impedance	<20mΩ
Current accuracy	RMS measure, accuracy class 0.5
Frequency	45~60Hz, accuracy 0.1Hz
Power	Active / Reactive / Apparent power, accuracy 0.5%
Energy	4 quadrant calculation, Accuracy (Kwh) 0.5%, Accuracy (Kvarh): 1%
Display	Programmable setting, switch display in cycle, 3 lines LED display
Power supply range	AC/DC 100V~240V
Power supply consumption	≤5VA
Output digital interface	Standard RS-485, MODBUS-RTU
Pulse output	2 loop energy pulse output (Optical coupler relay)
On-Off input	2 loop On-Off input (Connection without voltage or current signal)
Alarm output	2 loop on-off output , 250V AC/3A or 30V DC/5A
Analog output	1 transformed analog output, 4-20mA DC
Working environment	Temperature : -10~55℃ Humidity: <85% RH
Storage environment	-20~75℃
Withstand voltage	Input to power supply: 1600VAC, input to output: 1600VAC, power supply to output: 1600VAC
Isolation	Input / output / power supply to meter cover: >5MΩ
Dimension (mm)	96W×96H×100L
Weight	0.6kg

4. Panel illustration

EW9A Panel Indication

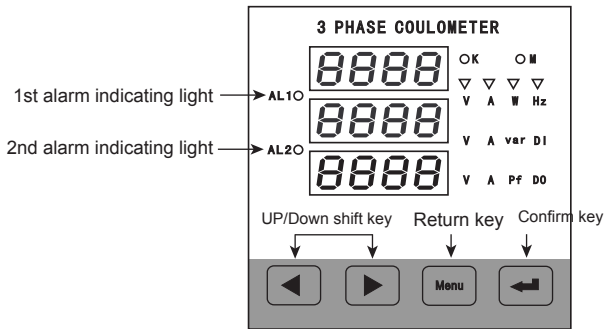

6 group display value:
 Voltage: Ua, Ub, Uc Current: Ia, Ib, Ic
 Power & power factor: W, Var, Pf
 Frequency & On-Off input / output: Hz, DI, DO
 KWH: KWh (press key to display)
 KvarH: KVarh (press key to display)

EW9B Panel Indication

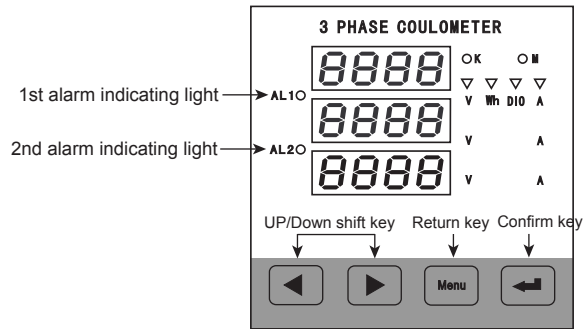

4 group display value :
 Voltage: Ua, Ub, Uc
 KWH: KWh
 On-Off input / output : DIO
 Current: Ia, Ib, Ic

EW9C Panel Indication

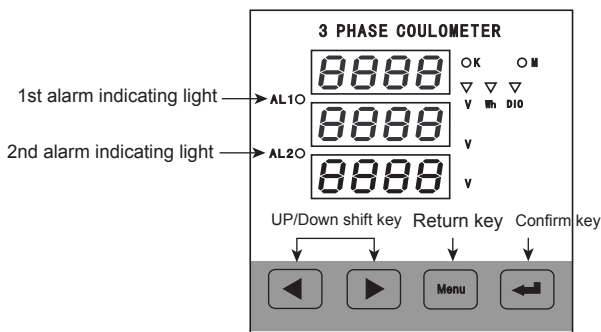

3 group display value :
 Voltage: Ua, Ub, Uc
 KWH: KWh
 On-Off input / output: DIO

EW9D Panel Indication

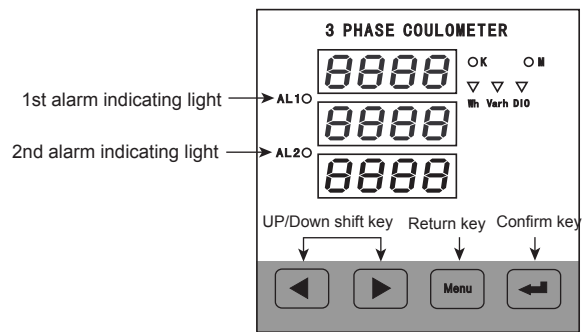

3 group display value :
 KWH: KWh
 KvarH: KVarh
 On-Off input / output: DIO

EW9E Panel Indication

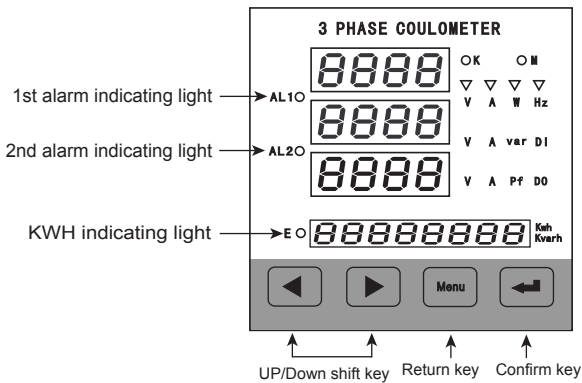

6 group display value :
 Voltage: Ua, Ub, Uc
 Current: Ia, Ib, Ic
 Frequency & On-Off input / output: Hz, DI, DO
 Power & power factor: W, Var, Pf
 KWH: KWh
 KvarH: KVarh

Panel indication (indicating light)

K: Kilo unit
 M: Million unit
 V: Voltage
 DO: on-off putput or alarm
 A: current
 W: active power
 Var: reactive power
 pf: power factor
 Hz: frequency
 DI: on-off input
 Wh: Kwh
 Varh: KvarH

- Note: 1. In measure status , press ◀ or ▶ to switch display , display value match with right units and indicating light.
2. EW9A , EW9B , EW9C , EW9D power meter , when switch display in the first line LED as Kwh , the sccond line and third line combined together to display the 8 digit Kwh value. for example , Kwh is 45632318 , the second line display 4563 , the third line display 2318. Another example , if Kwh is 2516 , then only the third display 2516 . When display Kvarh , the second line and third line combined together to display the 8 digit KvarH value.
3. EW9E power meter , press ◀ key to switch kwh display and Kvarh display . E indication light is on , it means display Kwh value , when E indication light is off , it displays Kvarh .

5. Operation Menu

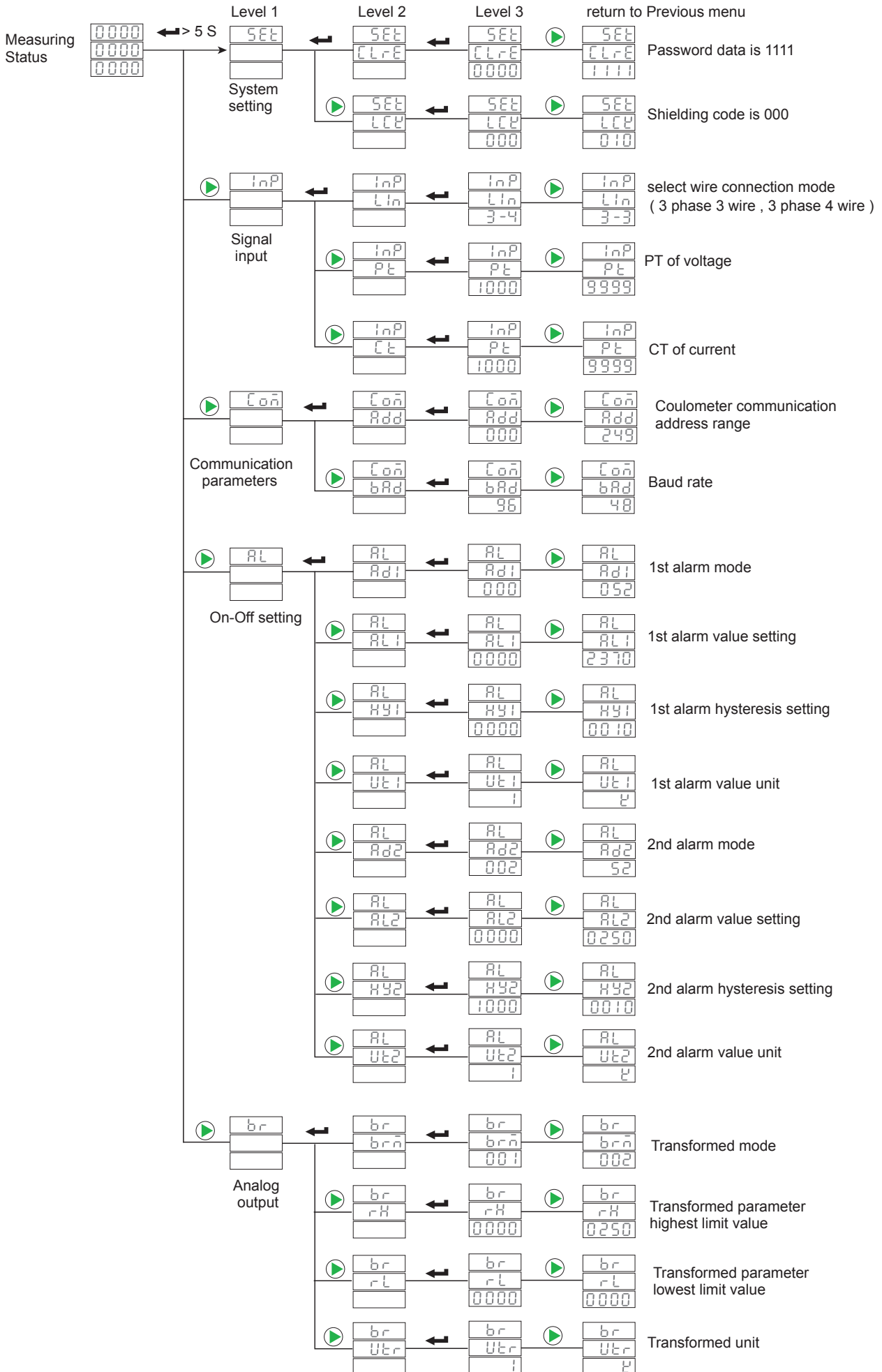

6. Operation indication

1) In the measuring status

1. Press “◀” or “▶” key to shift the display value group.
2. Press confirm key “↵” to shift the voltage display value between phase voltage and line voltage. And switch the display of Kwh and Kvarh for EW9E series meter. E indicate light is on, display Kwh value, E indication light is off, display Kvarh value.
3. Press confirm key “↵” for more than 5 seconds to enter setting menu, for operation details please read the below menu structure.

In the setting menu status

1. If the current menu is 1st or 2nd level, press confirm key “↵” to show the next level menu. Press “◀”, “▶” to change menu option or sub-menu option.
2. If the current menu is 2nd or 3rd level, press “Menu” key to return to last level.
3. If the current menu is 3rd level, press “◀”, “▶” key to change the value. Press “◀” or “▶” (not release) to change the value continuously. Press confirm key “↵” to save the setting value and return to level 2 display. Press “Menu” key to return to level 2, setting value is not saved.
4. If the current menu is at level 3, press “◀” and “▶” key at the same time to shift the decimal point.
5. After value change, press confirm key “↵” for more than 5 seconds to exit the user menu and return back to measuring status.

The keys for program operation are as below:

i.e.: Left, Right shift key “◀”, “▶”, Return key “MENU”, Confirm key “↵”.

“◀”, “▶”, Shift / Change key, to shift the menu or increase / decrease value. For example, in the menu of InP-Pt, press “▶” key, it will be changed to InP-Ct. Press “◀” or “▶” without release to change value continuously.

No.	Level 1	Display	Level 2	Level 3	Indication
1	SEt System setting	CLrE	Clear energy	Password 0000	Energy can be cleared only if the input password is correct.(Password:1111)
		LCY	Function shielding password	Shielding password 000	If the second digit is “1” (i.e.010), the value in the menu can be read but not changed.
2	InP Signal input	LIIn	Network LIIn	3-3 3-4	To select the input network (3 phase 3 wire/ 3 phase 4 wire)
		Pt	Voltage transform Pt	1-9999	To set the voltage signal ratio= Primary coil voltage / Secondary coil voltage (VoltageTransformer)
		Ct	Current transform Ct	1-9999	To set the current signal ratio= Primary coil current / Secondary coil current (Current Transformer)
3	Coñ Communication parameters	AdD	Address AdD	0-255	Coulometer address range
		bAd	Baud rate bAd	4.8-9.6	Baud rate: 4.8 means 4800, 9.6 means 9600
4	AL On-Off setting AL	Ad1	1st alarm mode Ad1	1-52	When the value is 0, it is for DO function, otherwise it is for alarm mode. Please refer to Table 1.
		AL1	1st alarm value AL1	-1999-9999	1st alarm value setting
		HY1	1st alarm hysteresis value HY1	-1999-9999	1st alarm hysteresis value setting
		Ut1	1st alarm value unit	1-2	1: means international standard unit, K: means 1000 times of international standard unit, the unit of alarm value is the same as alarm hysteresis value.
		Ad2	2nd alarm mode Ad2	1-52	When the value is 0, it is for DO function, otherwise it is for alarm mode, please refer to Table 1 on page 7.
		AL2	2nd alarm value AL2	-1999-9999	2nd alarm value setting
		HY2	2nd alarm hysteresis value HY2	-1999-9999	2nd alarm hysteresis value setting
		Ut2	2nd alarm value unit	1-2	1: means international standard unit, K: means 1000 times of international standard unit, the unit of alarm value is the same as alarm hysteresis value.
5	br Analog output	brñ	Transform mode selection	1-26	Please refer to Table 1 on page 7.
		rH	Transform highest value	-1999-9999	Transform analog output 20mA
		rL	Transform lowest value	-1999-9999	Transform analog output 4mA
		Utr	Transform value unit	1-2	1: means international standard unit, K: means 1000 times of international standard unit.

7. Output function

1. Energy pulse

EW9 provides the function of 4 quadrant energy calculation, 2 energy pulse output and RS485 interface for display and transmit of energy data.

Coulomter has 3 lines 4 digit LED to display the 2nd coil active energy and reactive energy.

The energy pulse of optical couple relay with open collector enables the long distance transmit of active & reactive energy

Remote PC terminal, PLC, DI On-Off output and collector module are applied to collect the pulse of coulometer to enable the energy cumulation calculation.

Besides, this output mode is also the energy accuracy check way (National metrology regulations: Standard meter pulse tolerance comparison method.)

(1) Electrical characteristic: the output of optical couple relay with open collector, $V \leq 48V$, $I_z \leq 50mA$

(2) Pulse constant: 7200imp/KWh. It means: The impulse output no. is 7200 when the coulometer counts up to 1KWH.

The point should be emphasized is that the above 1kWh is for the 2nd coil energy. Supposed that PT and CT is connected, the primary coil energy that 7200 pulse refers to is equal to 1kWh X voltage transform PT X current transform CT.

2. DI/DO function 2 DI is used to remote measure electrical on / off status. 2 DO is used to remote control electrical devices. When DO function is used, alarm mode is set as "0", control value is written via RS485 interface.
3. Communication function (Please refer to the Communication protocol)
4. Transform output (Please refer to Table 1)
5. Alarm function (Please refer to Table 1)

8. Communication protocol

EW9 series coulometer adopts Modbus RTU communication protocol, RS485 half duplex communication, read function code 0x03, write function code 0x10, adopts 16 digit CRC check, the coulometer does not feedback check error.

Data frame format:

Start bit	Data bit	Stop bit	Check bit
1	8	1	No

Communication abnormal solution:

When abnormal answer, the highest bit of function code will be set to 1. For example, if the request function code from master unit is 0x04, the return function code from the meter is 0x84.

Error type code

0x01---Function code error: The meter does not support the function code it receives.

0x02---Data position error: The data position assigned by host is out of the range of meter

0x03---Data value error: The data value sent from host is out of the range of meter.

8.1. Read multi-register

For example, master unit reads float data AL1 (1st alarm value 241.5)

The address code of AL1 is 0x0000, because AL1 is float data(4 byte), seizes 2 data register. According to IEEE-754, the standard hexadecimal memory code of decimal float data 241.5 is 0x00807143.

Master unit request (Read multi-register)							
1	2	3	4	5	6	7	8
Meter address	Function code	Start address High bit	Start address Low bit	Data byte length High bit	Data byte length Low bit	CRC code Low bit	CRC code high bit
0x01	0x03	0x00	0x00	0x00	0x02	0xC4	0x0B

Slave unit answer (Read multi-register)								
1	2	3	4	5	6	7	8	9
Meter address	Function code	Data byte number	Data 1 High bit	Data 1 Low bit	Data 2 High bit	Data 2 Low bit	CRC code Low bit	CRC code high bit
0x01	0x03	0x04	0x00	0x80	0x71	0x43	0x9E	0x7A

Function code abnormal answer:(For example, master unit request function code is 0x04)

Slave unit abnormal answer(Read multi-register)				
1	2	3	4	5
Meter address	Function code	Error code	CRC code Low bit	CRC code high bit
0x01	0x84	0x01	0x82	0xC0

8.2. Write multi-register

For example: Master unit reads float data HY1 (1st alarm hysteresis value 20.5). The address code of HY1 is 0x0001, because HY1 is float data (4 bytes), seizes 2 data registers. According to IEEE-754 standard, the hexadecimal memory code of decimal float data 20.5 is 0x0000A441.

Master unit request (Write multi-register)												
1	2	3	4	5	6	7	8	9	10	11	12	13
Meter address	Function code	Start address High bit	Start address Low bit	Data byte length High bit	Data byte length Low bit	Data byte length	Data 1 high bit	Data 1 low bit	Data 2 high bit	Data 2 low bit	CRC code Low bit	CRC code high bit
0x01	0x10	0x00	0x01	0x00	0x02	0x04	0x00	0x00	0xA4	0x41	0x88	0x93

Slave unit normal answer (Write multi-register)							
1	2	3	4	5	6	7	8
Meter address	Function code	Start address High 8 bit	Start address Low 8 bit	Data byte length High bit	Data byte length Low bit	CRC code Low bit	CRC code high bit
0x01	0x10	0x00	0x01	0x00	0x02	0x10	0x08

Data position error answer:(For example, master unit request write address index is 0x0050)

Slave unit abnormal answer (Write multi-register)				
1	2	3	4	5
Meter address	Function code	Error code	CRC code Low bit	CRC code high bit
0x01	0x90	0x02	0xCD	0xC1

3. EW parameter address reflection table (Note: address code is the index of variable array)

No.	Address code	Variable name	Default value	Byte length	Value range	Read / Write allowed	Remark
0	0x0000	1st alarm value AL1	250	2	-1999~9999	R/W	
1	0x0001	1st alarm hysteresis HY1	10	2	-1999~9999	R/W	
2	0x0002	2nd alarm value AL2	250	2	-1999~9999	R/W	
3	0x0003	2nd alarm hysteresis HY2	10	2	-1999~9999	R/W	
4	0x0004	Voltage transform PT	1.0	2	1~9999	R/W	
5	0x0005	Current transform CT	1.0	2	1~9999	R/W	
6	0x0006	Analog output highest value RH	250	2	-1999~9999	R/W	
7	0x0007	Analog output lowest value RL	0.0	2	-1999~9999	R/W	
8	0x0008	Phase voltage Ua		2	0~9999	R	
9	0x0009	Phase voltage Ub		2	0~9999	R	
10	0x000A	Phase voltage Uc		2	0~9999	R	
11	0x000B	Line voltage Uab		2	0~9999	R	
12	0x000C	Line voltage Ubc		2	0~9999	R	
13	0x000D	Line voltage Uca		2	0~9999	R	
14	0x000E	Phase current Ia		2	0~9999	R	
15	0x000F	Phase current Ib		2	0~9999	R	
16	0x0010	Phase current Ic		2	0~9999	R	
17	0x0011	Phase A active power Pa		2	0.000~9999	R	
18	0x0012	Phase B active power Pb		2	0.0000~9999	R	
19	0x0013	Phase C active power Pc		2	0.000~9999	R	
20	0x0014	Total active power Ps		2	0.000~9999	R	
21	0x0015	Phase A reactive power Qa		2	0.000~9999	R	
22	0x0016	Phase B reactive power Qb		2	0.000~9999	R	
23	0x0017	Phase C reactive power Qc		2	0.000~9999	R	
24	0x0018	Total reactive power Qs		2	0.000~9999	R	
25	0x0019	Phase A apparent power VAa		2	0.000~9999	R	
26	0x001A	Phase B apparent power VAb		2	0.000~9999	R	
27	0x001B	Phase C apparent power VAc		2	0.000~9999	R	
28	0x001C	Total apparent power VAs		2	0.000~9999	R	
29	0x001D	Power factor PFa		2	0~1.0	R	
30	0x001E	Power factor PFb		2	0~1.0	R	
31	0x001F	Power factor PFc		2	0~1.0	R	
32	0x0020	Total power factor PFs		2	0~1.0	R	
33	0x0021	Frequency		2	45~60	R	
34	0x0022	KWH		2	0.00Kwh-99.999999Mwh	R	
35	0x0023	KVarH		2	0.00Kvarh-99.999999Mvarh	R	
Reservation							
36	0x0050	Display group	0	1	0~5	R/W	
37	0x0051	1st alarm mode Ad1	2	1	0~52	R/W	Table 1
38	0x0052	2nd alarm mode Ad2	2	1	0~52	R/W	
39	0x0053	Analog output mode brM	1	1	1~26	R/W	Table 1
40	0x0054	1st alarm value unit	0	1	0~1	R/W	
41	0x0055	2nd alarm value unit	0	1	0~1	R/W	
42	0x0056	Analog output value unit	0	1	0~1	R/W	
43	0x0057	Connection mode Link	0	1	0~1	R/W	Remark ①
44	0x0058	Baud rate bAUd	1	1	0~1	R/W	Remark ②
45	0x0059	Meter address Add	1	1	0~255	R/W	
46	0x005A	On-Off value output DO		1	0~3	R	
47	0x005B	On-Off value input DI		1	0~3	R	
48	0x005C	Meter name	0xDA	1	0xDA	R	
49	0x005D	Measuring status indication		1	0~16	R	Remark ③

R/W----Read and Write

R----Read only

Table1: The table of alarm output and analog output mode

To select the code for the alarm mode. For example, if users want to choose Phase A voltage Low alarm, they can set the Ad1 (1st alarm mode) as 1, so 1st alarm is low alarm for Ua. For other alarm mode,the setting is similar.

No.	Item	On-Off value output (Low alarm) code	On-Off value output (High alarm) code	Analog output (4-20mA) Code
1	Ua(Phase A voltage)	1	2	1
2	Ub(Phase B voltage)	3	4	2
3	Uc(Phase C voltage)	5	6	3
4	Uab(Line AB voltage)	7	8	4
5	Ubc(Line BC voltage)	9	10	5
6	Uca(Line CA voltage)	11	12	6
7	Ia(Line A current)	13	14	7
8	Ib(Line B current)	15	16	8
9	Ic(Line C current)	17	18	9
10	Pa(Phase A active power)	19	20	10
11	Pb(Phase B active power)	21	22	11
12	Pc(Phase C active power)	23	24	12
13	Ps(Total active power)	25	26	13
14	Qa(Phase A reactive power)	27	28	14
15	Qb(Phase B reactive power)	29	30	15
16	Qc(Phase C reactive power)	31	32	16
17	Qs(Total reactive power)	33	34	17
18	Sa(Phase A apparent power)	35	36	18
19	Sb(Phase B apparent power)	37	38	19
20	Sc(Phase C apparent power)	39	40	20
21	Ss(Total apparent power)	41	42	21
22	PFa(Phase A power factor)	43	44	22
23	PFb(Phase B power factor)	45	46	23
24	PFc(Phase C power factor)	47	48	24
25	PFs(Total power factor)	49	50	25
26	F(Frequency)	51	52	26

Remark ①: Connection mode

Communication value	0	1
Menu display	3-4	3-3

Remark ②: Baud rate

Communication value	0	1
Menu display	4.8	9.6

Remark ③: Measure status indication

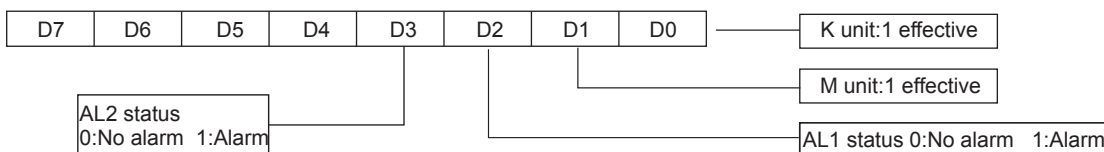

The program of 4 byte character code float data converting to decimalist float data
float BytesToFloat (unsigned char*pch)

```

{
    float result;
    unsigned char *p;
    p=(unsigned char*)&result;
    *p=*pch;*(p+1)=*(pch+1);*(p+2)=*(pch+2);*(p+3)=*(pch+3);
    return result;
}

```

The program of decimalist float data converting to 4 byte character code float data as per IEEE-754 standard
void FloatToChar(float Fvalue,unsigned char*pch)

```

{
    unsigned char*P;
    p=(unsigned char*)&Fvalue;
    *pch=*p;*(pch+1)=*(p+1);*(pch+2)=*(p+2);*(pch+3)=*(p+3);
}

```

The program of achieving 16 bit CRC check code
unsigned int Get_CRC (uchar*pBuf,uchar num)

```

{

```



```

unsigned i,j;
unsigned int wCrc=0xFFFF;
for(i=0;i<num;i++)
{
    wCrc^=(unsigned int)(pBuf[i]);
    for(j=0;j<8;j++)
    {
        if(wCrc & 1){wCrc>>=1; wCrc=0xA001;}
        else wCrc>>=1;
    }
}
return wCrc;
}
}

```

9. Installation mounting dimension

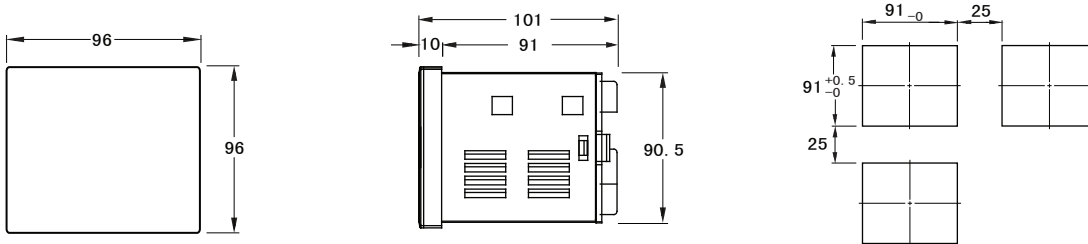

10. Connection drawing

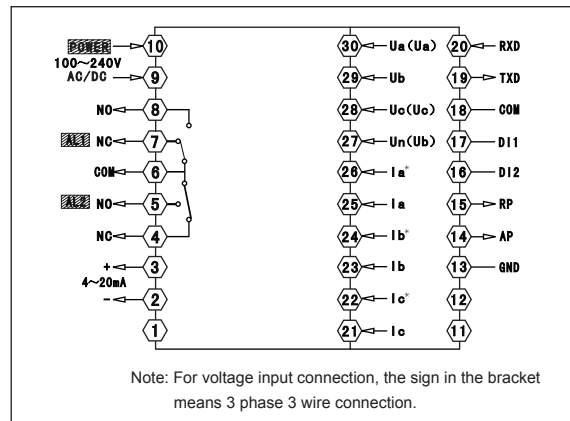

Mode 1 (3 pcs CT): 3 phase 4 wire working mode with central line

Mode 2 (2 pcs CT): 3 phase 3 wire working mode

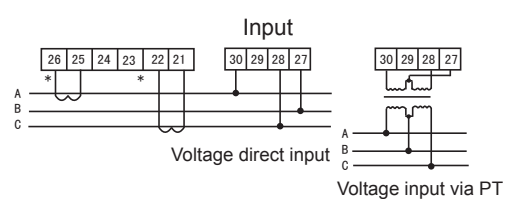
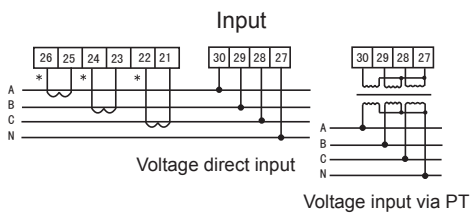

Explanation:

- Voltage input: Input voltage should not be higher than the rated input voltage of meter (450V), otherwise a PT should be used.
- Current input: Standard rated input current is 5A. A CT should be used when the input current is bigger than 5A. If some other meters are connected with the same CT, the connection should be serial for all meters.
- Please make sure that the input voltage is corresponding to the input current, they should have the same phase sequence and direction, otherwise data and sign error may occur (power and energy).
- The connection mode of meter which is connected to power network should depend on the CT quantity. For 2pcs of CT, it should be 3 phase 3 wire connection. For 3 pcs of CT, it should be 3 phase 4 wire connection.
Meter wire connection, the input network Link setting in the software menu should accord to the connection mode of the measured load. Otherwise, the measured voltage or power is incorrect.
- Please pay high attention on the difference between 3 phase 3 wire and 3 phase 4 wire connection. Because wrong connection may lead to incorrect calculation of power factor, power and energy.

Caution

- Power supply connection must be correct.
- Pay attention on the phase sequence of voltage signal input.
- Current signal input should be connected as per the connection drawing.
- Connection mode should be according to the setting of user menu Link.
- Energy pulse output is open collector output.